



Smith+Nephew

BIRMINGHAM HIP[◇]
Resurfacing System

Implant and Instrumentation
Catalogue

Table of contents

Implants	1
Templating	2
Instrument tray layout	4
Instruments	10
Additional instruments	17

Implants

BHR® Resurfacing Head

Cat. no.	Size
74123148	48mm
74121150	50mm
74123152	52mm
74121154	54mm
74123156	56 mm
74121158	58mm



BHR Acetabular Cup

Cat. no.	Size
74122154	54mm (48 head)
74122156	56mm (48 head)
74120156	56mm (50 head)
74120158	58mm (50 head)
74122158	58mm (52 head)
74122160	60mm (52 head)
74120160	60mm (54 head)
74120162	62mm (54 head)
74122162	62mm (56 head)
74122164	64mm (56 head)
74120164	64mm (58 head)
74120166	66mm (58 head)



Templating

Implant size chart (2mm)

Cat. No. 02839

BHR ^o Implant size chart		Smith+Nephew	
BIRMINGHAM HIP ^o		Resurfacing System	
HEAD SIZE	CUP SIZE		
48	54	56	
50	56	58	
52	58	60	
54	60	62	
56	62	64	
58	64	66	

IMPORTANT: NEVER mix colours on heads and cups.

* Trademark of Smith & Nephew 04388 V2 04/16

BHR[◇] X-Ray templating set (2mm)

Set of 6 templates (115% magnification)
Cat. No. 0216-3015

Set of 6 templates (120% magnification)
Cat. No. 0216-3020

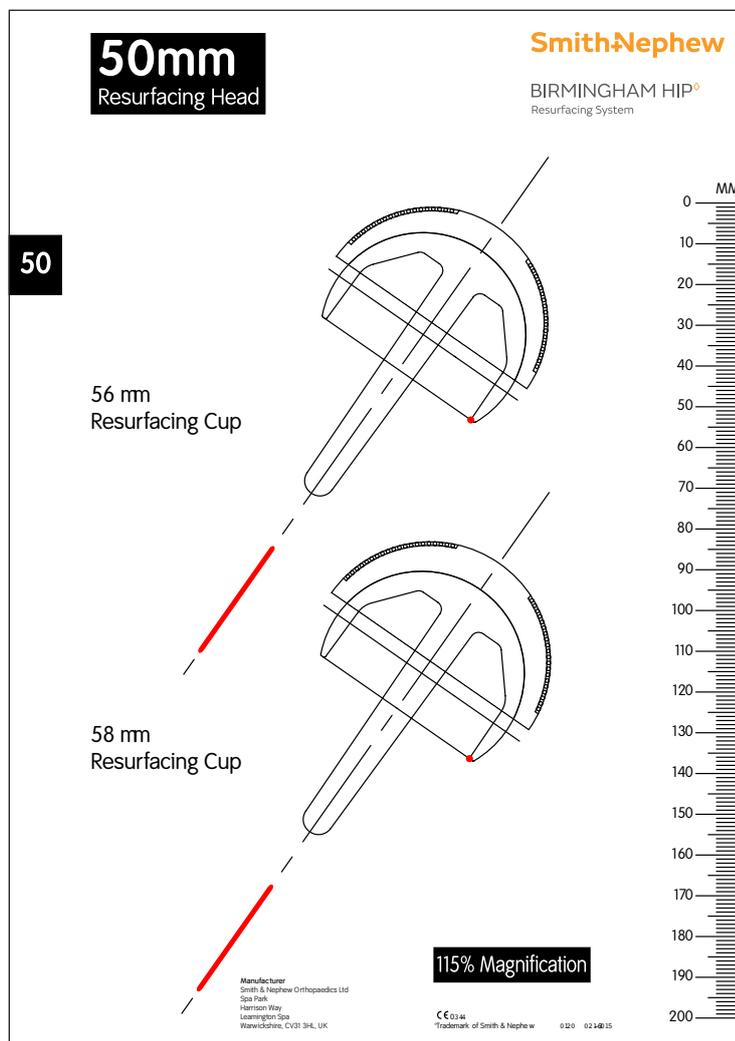

Sample template (Not to Scale)

Instrument tray layouts

BHR[◇] General Instrument Tray (single tray)

Cat. No. 90129071

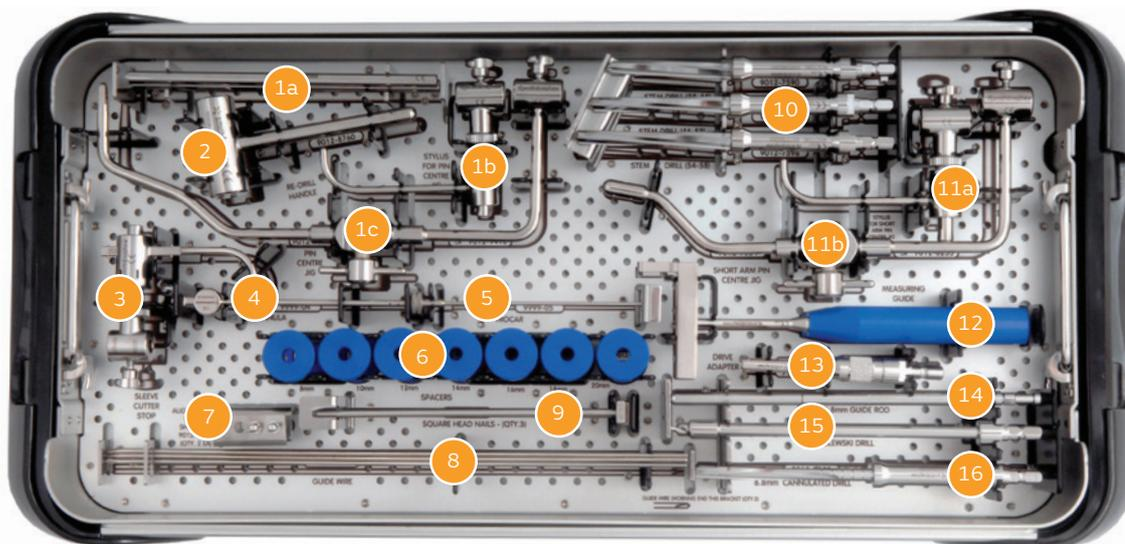

Catalog # Description

1a	90129412	Pin Centre Jig (11 settings) 1a: Central Cannulated Rod 1b: Stylus (11 settings) 1c: Pin Centre Jig
2	90128760	Re-drill Handle
3	90123291	Sleeve Cutter Stop (11 settings)
4	999904	Cannula
5	999905	Trocar
6	90123208	Spacer 8mm
	90123210	Spacer 10mm
	90123212	Spacer 12mm
	90123214	Spacer 14mm
	90123216	Spacer 16mm
	90123218	Spacer 18mm
	90123220	Spacer 20mm
7	901002	Alignment Pin (single use)
	90129125	Short Pin (for use with Short Arm Pin Centre Jig)
8	901003	Guide Wires (single use)

Catalog # Description

9	999908	Square Head Nails
10	90127593	Stem Drill 46-52mm
	90127596	Stem Drill 54-58mm
11	90128255	Short Arm Pin Centre Jig 1a: Central Cannulated Rod 11a: Stylus (11 settings) 11b: Short Arm Pin Centre Jig
12	90129155	Measuring Guide
13	90129135	Drive Adaptor
14	90127585	6.8mm Guide Rod
15	90127557	Wroblewski Drill
16	90127540	6.8 Cannulated Twist Drill

Acetabular Preparation Tray 1 (single tray)

Cat. No. 90129051

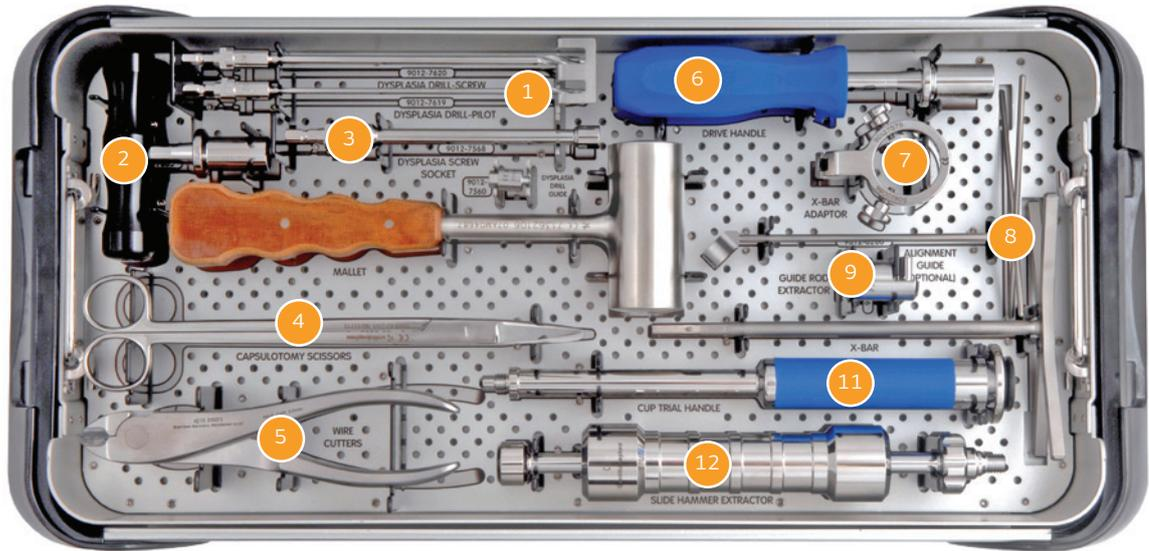

Catalog #	Description
1	90127619 Dysplasia Drill-Pilot
2	90127635 T-Handle
3	90127568 Dysplasia Screw Socket
4	999907 Capsulotomy Scissors
5	210272* Wire Cutters
6	71362294* Ratchet Handle
7	90127575 X-Bar Adaptor (for use with Cup Introducer - 900001)
8	90128280 Alignment Guide (optional)
9	90127563 Guide Rod Extractor
10	MT2201* X-Bar (for use with Curved Cup Introducer - 90128257 and Straight Cup Introducer - 900001)
11	90127554 Cup Trial Handle
12	90127556 Slide Hammer Extractor

* Legal Manufacturer Smith+Nephew, Inc.

Instrument trays (continued)

Acetabular Preparation tray 2 (single tray)

Cat. No. 90129052

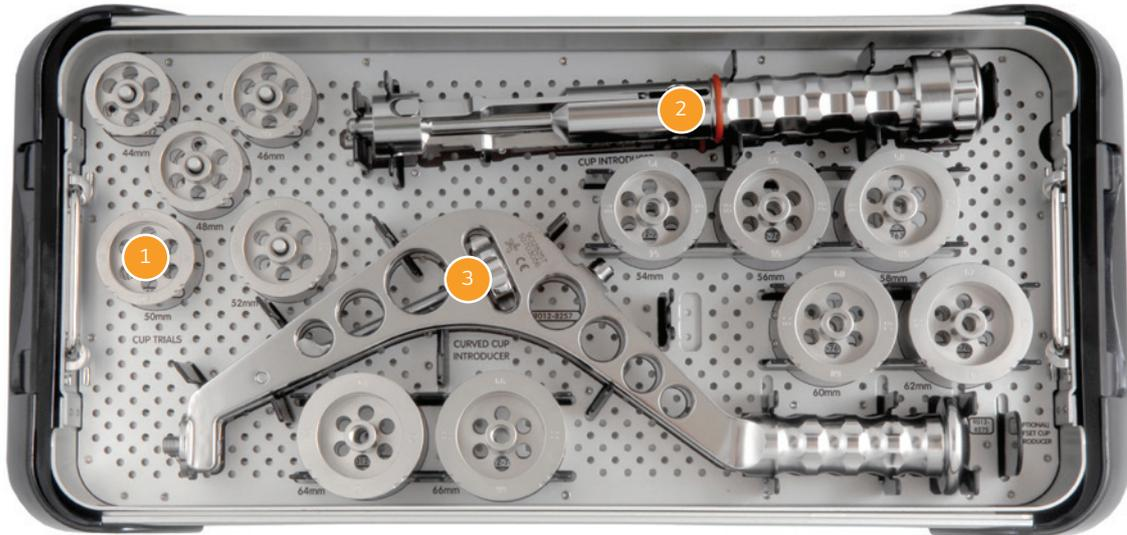

Note: only cup sizes 54-66mm are available.

Catalog #	Description
1	90127627 Cup Trial 54mm
	90127628 Cup Trial 56mm
	90127629 Cup Trial 58mm
	90127630 Cup Trial 60mm
	90127631 Cup Trial 62mm
	90127632 Cup Trial 64mm
	90127633 Cup Trial 66mm
2	900001 Straight Cup Introducer
3	90128257 Curved Cup Introducer

Acetabular Preparation tray 2

(Optional instrument configuration with Offset Introducer)

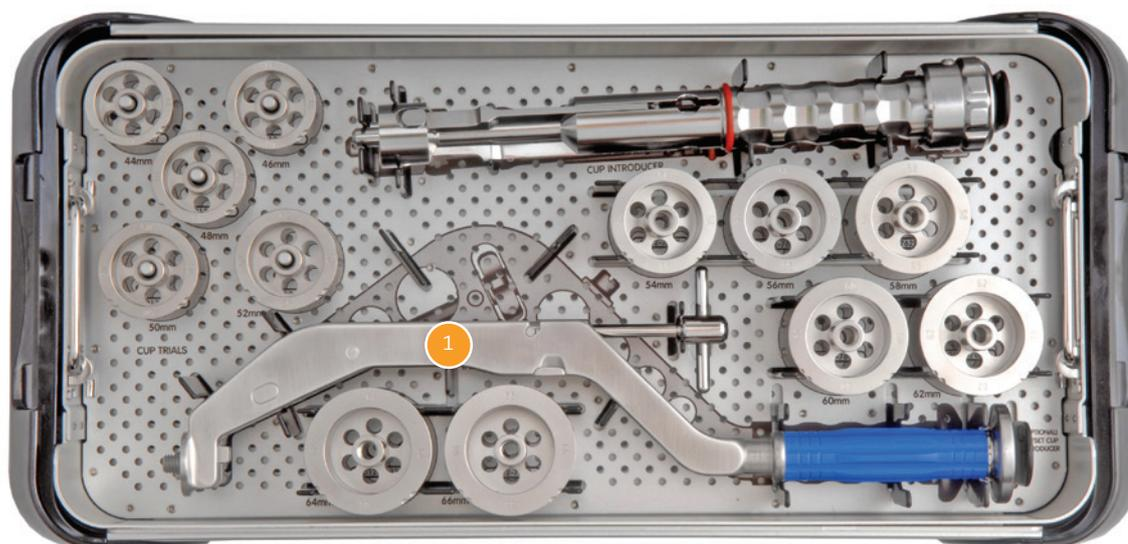

Note: Alignment Guide (Cat. No. 90128280) is required for use with the Offset Introducer.

Catalog #	Description
1 90128275	Offset Introducer

Instrument trays (continued)

Femoral Preparation tray 1 (single tray)

Cat. No. 90129061

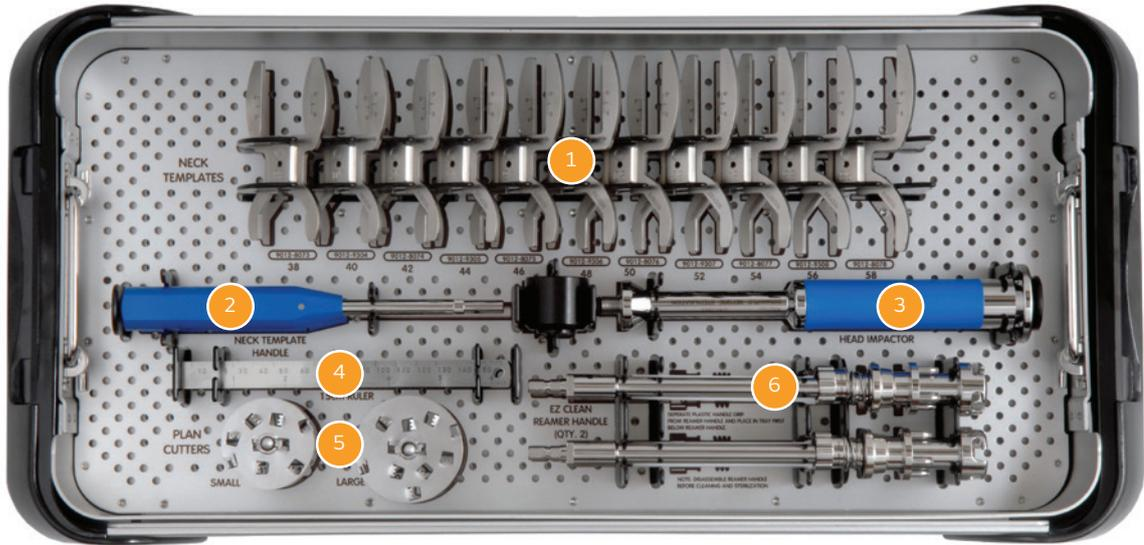

Note: only head sizes 48-58mm are available.

Catalog #	Description
1	90129306 Neck Template 48mm
	90128076 Neck Template 50mm
	90129307 Neck Template 52mm
	90128077 Neck Template 54mm
	90129308 Neck Template 56mm
	90128078 Neck Template 58mm
2	90128759 Neck Template Handle
3	71364009 * Head Impactor
4	90128254 15cm Ruler
5	90127613 Plan Cutter Small
	90127614 Plan Cutter Large
6	90127621 EZ Clean Reamer Handle

* Legal Manufacturer Smith+Nephew, Inc.

Femoral Preparation Tray 2 (single tray)

Cat. No. 90129062

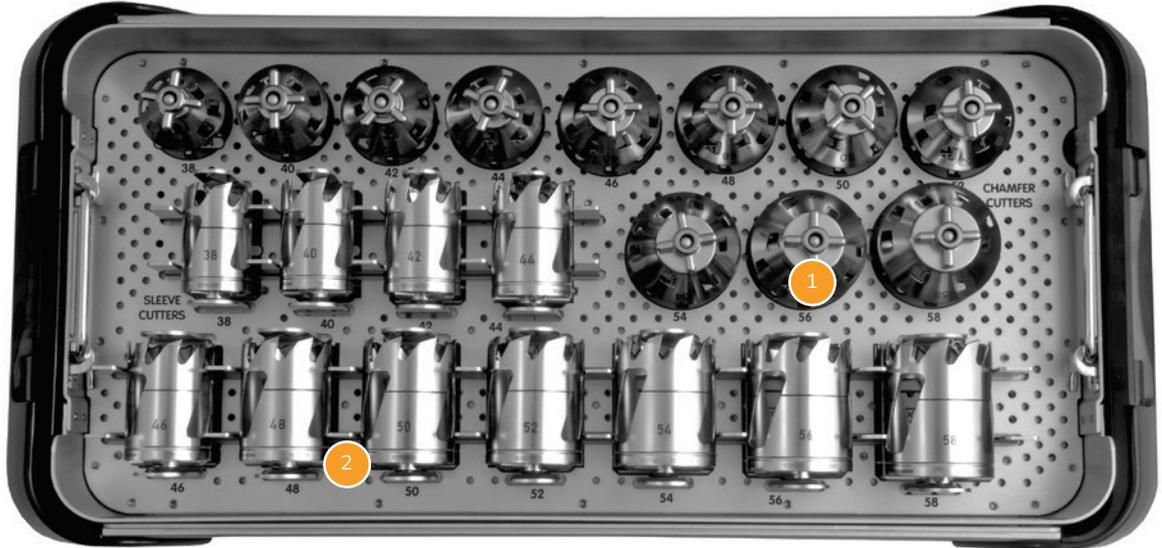

Note: only head sizes 48-58mm are available.

Catalog #	Description	Catalog #	Description
1 90129264	Chamfer Cutter 48mm	2 90129258	Sleeve Cutter 48mm
90127607	Chamfer Cutter 50mm	90127600	Sleeve Cutter 50mm
90129265	Chamfer Cutter 52mm	90129259	Sleeve Cutter 52mm
90127608	Chamfer Cutter 54mm	90127601	Sleeve Cutter 54mm
90129266	Chamfer Cutter 56mm	90129260	Sleeve Cutter 56mm
90127609	Chamfer Cutter 58mm	90127602	Sleeve Cutter 58mm

Single Height Case

Cat. No. 71129401*



Case Lid

Cat. No. 71129402*



* Legal Manufacturer Smith+Nephew, Inc.

Instruments

Set# BHR^o Full Set 90129080

Catalog #	Description	Qty.
90128760	Re-Drill Handle	1



Catalog #	Description	Qty.
90129412	Pin Centre Jig (11 Settings) Includes Central Cannulated Rod & Stylus	1



Catalog #	Description	Qty.
901002	Alignment Pin (single use)	1



Catalog #	Description	Qty.
90123291	Sleeve Cutter Stop (11 settings)	1



Catalog #	Description	Qty.
90123208	Spacer 8mm	1
90123210	Spacer 10mm	1
90123212	Spacer 12mm	1
90123214	Spacer 14mm	1
90123216	Spacer 16mm	1
90123218	Spacer 18mm	1
90123220	Spacer 20mm	1



Catalog #	Description	Qty.
999904	Cannula	1



Catalog #	Description	Qty.
999905	Trocar	1



Catalog #	Description	Qty.
901003	Guide Wire (single use)	1



Catalog #	Description	Qty.
999908	Square Head Nails	3



Catalog #	Description	Qty.
90127593	Stem Drill 46-52mm	1
90127596	Stem Drill 54-58mm	1



Catalog #	Description	Qty.
90128255	Short Arm Pin Centre Jig Includes Central Cannulated Rod & Stylus	1



Catalog #	Description	Qty.
90129155	Measuring Guide	1



Catalog #	Description	Qty.
90129125	Short Pin (for use with Short Arm Pin Centre Jig)	2



Catalog #	Description	Qty.
90129135	Drive Adaptor	1



Instruments (continued)

Set# BHR[®] Full Set 90129080 (continued)

Catalog #	Description	Qty.
90127585	6.8mm Guide Rod	1



Catalog #	Description	Qty.
90127557	Wroblewski Drill	1



Catalog #	Description	Qty.
90127540	6.8 Cannulated Twist Drill	1



Catalog #	Description	Qty.
90127619	Dysplasia Drill Pilot	1



Catalog #	Description	Qty.
90127635	T-Handle	1



Catalog #	Description	Qty.
90127568	Dysplasia Screw Socket	1



Catalog #	Description	Qty.
999907	Capsulotomy Scissors	1



Catalog #	Description	Qty.
210272*	Wire Cutters	1



Catalog #	Description	Qty.
71362294*	Ratchet Handle	1



Catalog #	Description	Qty.
90127575	X-Bar Adaptor (for use with Cup Introducer- 900001)	1



Catalog #	Description	Qty.
90127563	Guide Rod Extractor	1



* Legal Manufacturer Smith+Nephew, Inc.

Instruments (continued)

Set# BHR^o Full Set 90129080 (continued)

Catalog #	Description	Qty.
MT2201*	X-Bar (for use with Curved Cup Introducer and Straight Cup Introducer)	1



Catalog #	Description	Qty.
90127554	Cup Trial Handle	1



Catalog #	Description	Qty.
90127556	Slide Hammer Extractor	1



Catalog #	Description	Qty.
90127627	Cup Trials 54mm	1
90127628	Cup Trials 56mm	1
90127629	Cup Trials 58mm	1
90127630	Cup Trials 60mm	1
90127631	Cup Trials 62mm	1
90127632	Cup Trials 64mm	1
90127633	Cup Trials 66mm	1



Catalog #	Description	Qty.
900001	Cup Introducer	1



* Legal Manufacturer Smith+Nephew, Inc.

Catalog #	Description	Qty.
90128257	Curved Cup Introducer	1



Catalog #	Description	Qty.
90128275	Offset Acetabular Introducer	1



Catalog #	Description	Qty.
90128280	Alignment Guide (for use with Offset Acetabular Introducer - 90128275)	1



Catalog #	Description	Qty.
90127575	Neck Templates 48mm	1
90128076	Neck Templates 50mm	1
90129307	Neck Templates 52mm	1
90128077	Neck Templates 54mm	1
90129308	Neck Templates 56mm	1
90128078	Neck Templates 58mm	1



Catalog #	Description	Qty.
90128759	Neck Template Handle	1



Catalog #	Description	Qty.
71364009*	Head Impactor	1



Catalog #	Description	Qty.
90128254	15cm Ruler	1



* Legal Manufacturer Smith+Nephew, Inc.

Instruments (continued)

Set# BHR^o Full Set 90129080 (continued)

Catalog #	Description	Qty.
90127614	Plan Cutter Small	1
90127613	Plan Cutter Large	1



Catalog #	Description	Qty.
90127621	EZ Clean Reamer Handle	2



Catalog #	Description	Qty.
90129264	Chamfer Cutter 48mm	1
90127607	Chamfer Cutter 50mm	1
90129265	Chamfer Cutter 52mm	1
90127608	Chamfer Cutter 54mm	1
90129266	Chamfer Cutter 56mm	1
90127609	Chamfer Cutter 58mm	1



Catalog #	Description	Qty.
90129258	Sleeve Cutter 48mm	1
90127600	Sleeve Cutter 50mm	1
90129259	Sleeve Cutter 52mm	1
90127601	Sleeve Cutter 54mm	1
90129260	Sleeve Cutter 56mm	1
90127602	Sleeve Cutter 58mm	1



Additional instruments

Set# 71362901

Catalog #	Description
71362281	REFLECTION [®] Primary Reamer Set



Catalog #	Description
71362742*	Reamer Dome 42
713627xx in 1mm incremental sizes	
71362764*	Reamer Dome 64



Catalog #	Description
71362279*	Reamer Handle



Set# 90051100 BHR[◇] Trial Head set

Catalog #	Description
90051150	Tray
90051048	48mm
90051050	50mm
90051052	52mm
90051054	54mm
90051056	56mm
90051058	58mm

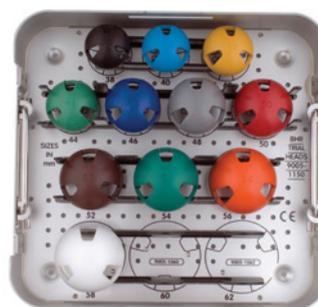

Note: only head sizes 48-58mm are available.

* Legal Manufacturer Smith+Nephew, Inc.

Additional instruments (continued)

Set# 90127725 Debris Cap set

Catalog #	Description
90127720	Tray
90127735	48mm
90127736	50mm
90127737	52mm
90127738	54mm
90127739	56mm
90127740	58mm

Note: only head sizes 48-58mm are available.



Set# 90072515

Catalog #	Description
90072510	Quick Wire Jig
90072514	Quick Wire Jig Tray



Catalog #	Description
90072512	Quick Wire Pivot / Central Rod (Spare Part for Quick Wire Jig)



Catalog #	Description
90072513	Alignment Guide (Spare Central rod for Quick Wire Jig)



Set# 90122035 Cup Removal Insert set

Catalog #	Description
90122036	Tray
90122038	44/46C - 38H INSERT
90122040	46/48C - 40H INSERT
90122042	48/50C - 42H INSERT
90122044	50/52C - 44H INSERT
90122046	52/54C - 46H INSERT
90122048	54/56C - 48H INSERT
90122050	56/58C - 50H INSERT
90122052	58/60C - 52H INSERT
90122054	60/62C - 54H INSERT
90122056	62/64C - 56H INSERT
90122058	64/66C - 58H INSERT



Note: only head sizes 38-58mm are available.

*Not available in US



Smith & Nephew Orthopaedics Ltd

Spa Park
Harrison Way
Leamington Spa
Warwickshire
CV31 3HL

www.smith-nephew.com

*Trademark of Smith+Nephew
All Trademarks acknowledged
©2020 Smith & Nephew, Inc.
02838-ous V3 (0216/0204) 03/20
Not for use in US

CE 0344