



BIRMINGHAM HIP[◇]

Resurfacing System

Table of contents

Surgical Approach	3
Pre-Operative Planning	3
Acetabular Preparation	5
Curved Cup Introducer	7
Acetabular Cup Wiring Instruction	8
Femoral Preparation	11
Using the McMinn Alignment Jig	12
Short Arm Alignment Jig Technique	14
Using the Sleeve Cutter Stop	18
Using the Stem Drill	27
Thrombo-embolic Prophylaxis	35
Catalogue Information	39

Nota Bene

The following technique is for informational and educational purposes only. It is not intended to serve as medical advice. It is the responsibility of treating physicians to determine and utilize the appropriate products and techniques according to their own clinical judgment for each of their patients. For more information on the product, including its indications for use, contraindications, and product safety information, please refer to the product's label and the Instructions for Use.

The surgical approach

The BIRMINGHAM HIP[®] Resurfacing device may be implanted through various hip surgical approaches. The posterior approach is described in this technique.

Pre-Operative planning

BHR[®] template sets (Figure 1) are used to determine component size and correct implant positioning. The position of the femoral component is a most important Pre-operative consideration. Varus positioning must be avoided and slight valgus is recommended (Figure 2).

To achieve optimal femoral component positioning, place the appropriate BHR template onto the X-Ray. Once happy with the size chosen the medial headneck junction may be identified to set up the correct template positioning. This is aided by using the cut out section on the template which allows implant position markings to be made with the template in situ.

With the head-neck-junction identified, the template is rotated around this point until desired valgus position is achieved with the implant's centre line. One limiting factor for implant positioning is the risk of femoral neck notching. This may be avoided at the templating stage by confirming there is no contact between the superior aspect of the femur and the template.

Once satisfied with the template positioning, the X-Ray may be marked on the lateral cortex of the femur using the appropriate cut-out section. The marked position shows the insertion point for the lateral pin used with the standard Head-Centre-Alignment-Jig.

The distance from the pin insertion point on the lateral femoral cortex to the tip of the greater trochanter is measured with the ruler found on the edge of each template. This measurement is translated intraoperatively onto the patient's femur to achieve optimal pin placement.

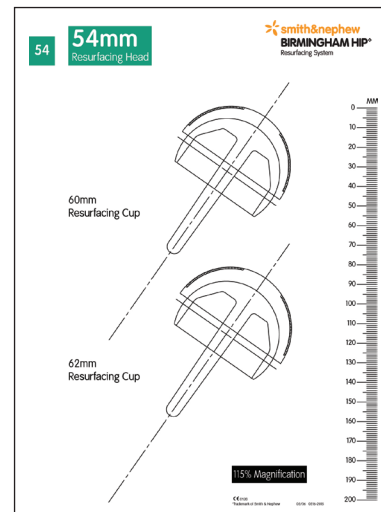

Figure 1

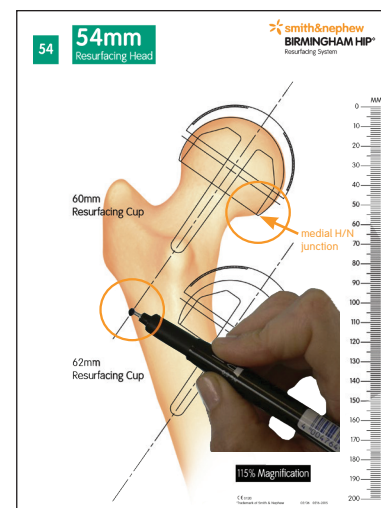

Figure 2

Intra-Operative templating

An assessment is made of the femoral neck diameter using the head/neck template. This provides vital information as to minimum head component size that can be safely used and also the minimum acetabular size that can be utilized. If significant osteophyte formation is present on the femoral neck then this should be removed with rongeurs before definitive assessment of femoral neck diameter is made (Figure 3,4).

Note: Care should be taken to avoid damage to the soft tissue and blood supply during osteophyte removal.

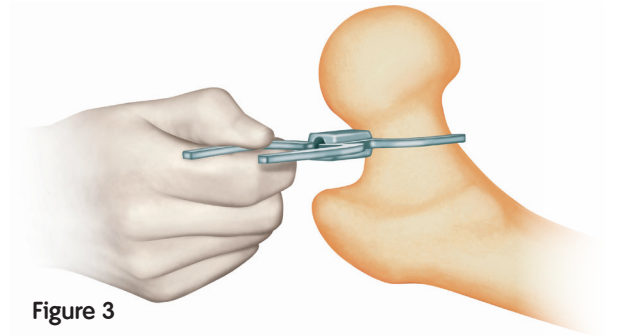

Figure 3

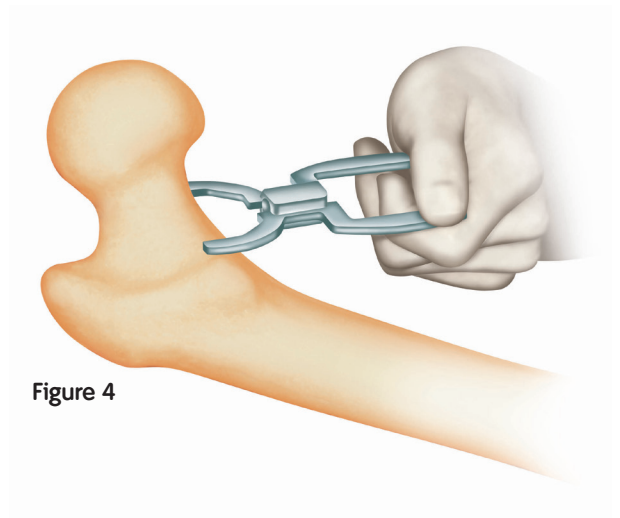

Figure 4

Acetabular preparation

If the antero-inferior capsule is tight an antero-inferior radial capsulotomy is made in line with the psoas tendon. A Hohmann retractor is placed inferior to the radiographic teardrop. The acetabular labrum, transverse ligament and ligamentum teres are excised revealing an unencumbered view of the complete acetabulum and a view of the true floor of the acetabulum. Sequential reaming with hemispherical acetabular reamers is then performed and in normal consistency bone, reaming proceeds to 2mm less than the definitive acetabular component to be inserted (Figure 5).

In large patients with soft cancellous bone 3mm under-reaming is recommended. In small patients with sclerotic acetabulae 1mm of under-reaming is recommended.

The cup trial may be used to determine correct implant positioning. If in doubt, medical tweezers can be used to identify optimal seating of the cup. The trial is 1mm smaller than the definitive component size (Figure 6).

Postero-inferior and antero-inferior osteophytes are excised to allow unobstructed cup insertion. Please note that some designs of acetabular reamers do not have teeth at the periphery and the acetabulum may be unreamed at its periphery making cup insertion difficult (Figure 7).

It is recommended to leave a rim of osteophyte to prevent Psoas impingement on the wall of the acetabular component, avoiding postoperative groin pain.

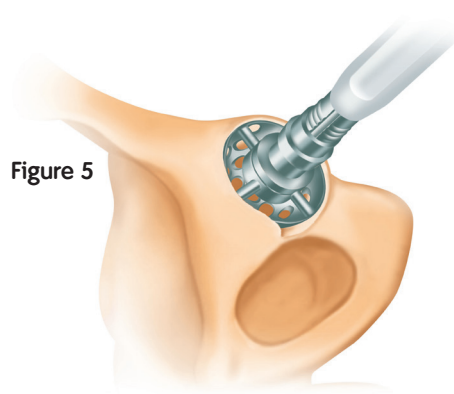

Figure 5

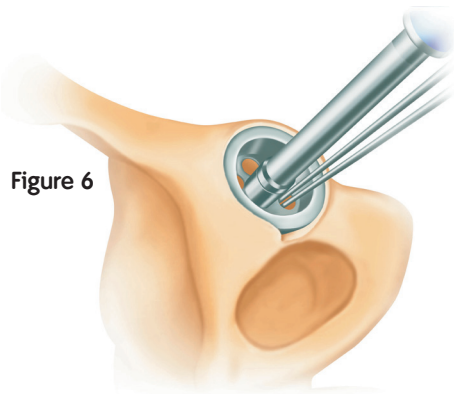

Figure 6

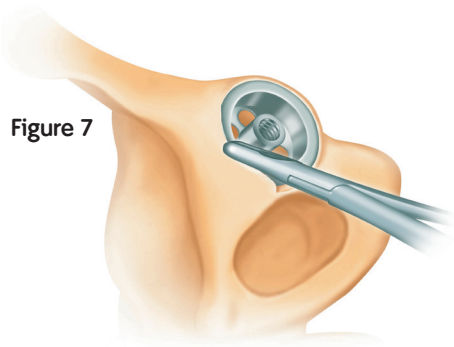

Figure 7

High Performance Cup Introducer Inspection Procedure

The following instructions should be followed to maintain the performance of the BHR[®] Cup Introducer:

- All instruments should be inspected before use. Any instrument found with a loose or a absent locking screw should be returned to Smith & Nephew for refurbishment. It is particularly important that a thread locking mechanism is used to secure the screws otherwise this problem may recur.
- There should be no excessive free play in the cable tensioning mechanism.

The desired size of acetabular component is mounted on the acetabular introducer and offered up to the acetabular rim. The acetabular cup is rotated so that its anti-rotation splines are adjacent to the ischium and pubis. The acetabular component is then fully impacted with 15-20° of anteversion and 40-45° inclination angle (Figure 8).

The acetabular introducer is removed and the polyethylene impactor cap is retracted at this stage to check that the acetabular component is correctly inserted. Adjustment of the cup position can be made by re-attaching the acetabular introducer. Cup removal is facilitated by the use of the slide hammer extractor attached to the acetabular introducer.

When it is certain that the component is correctly inserted, the cup introducer cables are cut and the cables and the polyethylene impactor cap removed (Figure 9). If the cup must be removed after the cables have been cut then separate cables and extractor assembly are available (code 900201&2). Any protruding osteophytes at the acetabular edge are removed with rongeurs. The femoral head is then reduced into the newly inserted acetabular component.

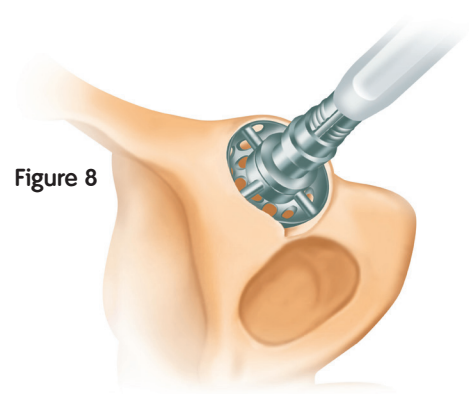

Figure 8

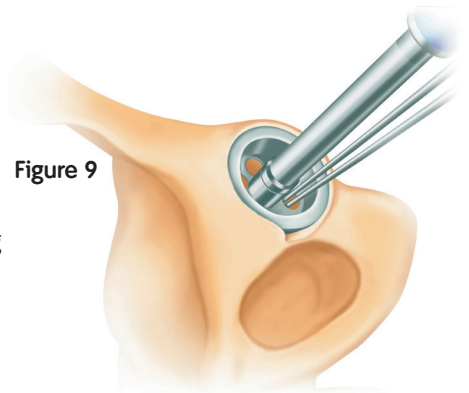

Figure 9

Cautionary statement.

When attaching the cup using the wires and cup introducer, tension should be applied until the cup is securely attached to the introducer assembly. Care should be taken with over tightening and excessive wire tension as this may lead to wire breakage.

Acetabular Cup Introducer Wire Removal Procedure

The following instructions should be followed to minimize the risk of separating the plastic coating when removing the introducer wire.

- Use appropriate wire cutters, in good condition, for the cutting task.
- Minimize the number of wormholes the wire is pulled through (multiple cuts).
- Avoid acute angles between the wire and the cup face during withdrawal.
- If the force required to remove the introducer wire is excessive, remove the wire by pulling it in the opposite direction.
- Check that the plastic coating is still present on the wires following the wires removal.

Curved Cup Introducer

These instructions provide important information regarding assembly and wiring for use of the BHR® curved cup introducer.

NOTE: This curved cup introducer is for use with BHR Resurfacing cups only. It is advised that when using Dysplasia cups the standard straight introducer should be used.



Acetabular Cup Wiring Instruction

The following is the recommended method of attaching the curved cup introducer to the acetabular component.

To ensure correct component fixation, please note that the wire loops are specified as wire loops 1, 2, and 3.

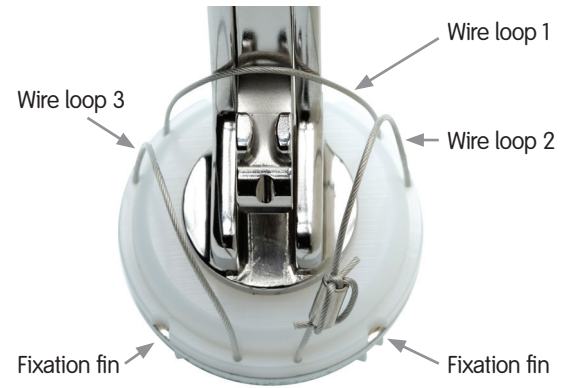

Figure 1

Step 1

The acetabular component is placed over the threaded spigot on the face plate of the introducer, with the introducer passing through wire loop 1.

To ensure correct alignment, check that the fixation fins of the acetabular component are positioned either side of the device (Figure 1, 2).



Figure 2

Step 2

Wire number 2 is then looped over the wire grip (Figure 3).

Note: retracting the wire grip a small way, using the thumb wheel, will apply some tension to the wires and may aid the assembly.



Figure 3

Step 3

As in Step 2, now loop wire 3 over the wire grip (Figure 4).

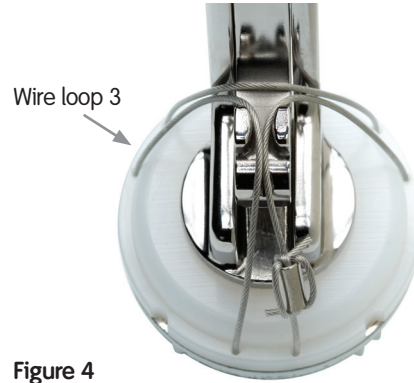

Figure 4

Step 4

With the two opposing wire loops (2 and 3) positioned through the wire grip now capture both wires by passing wire loop 1 over the top (Figure 5).



Figure 5

Step 5

When satisfied that the cup wires are suitably positioned, secure the device by tightening the thumb wheel to a satisfactory tension (Figure 6).



Figure 6

X-Bar

X-Bar (Figure 7)



Figure 7

The X-Bar is attached to the curved Cup Introducer. (Figure 8)



Figure 8

With the patient positioned correctly align the impactor so that the appropriate bar on the guide, left or right, is parallel to the longitudinal axis of the patient while the vertical bar is perpendicular to the floor. This will provide approximately 40-45° of abduction and 15-20° of anteversion. (Figure 9)

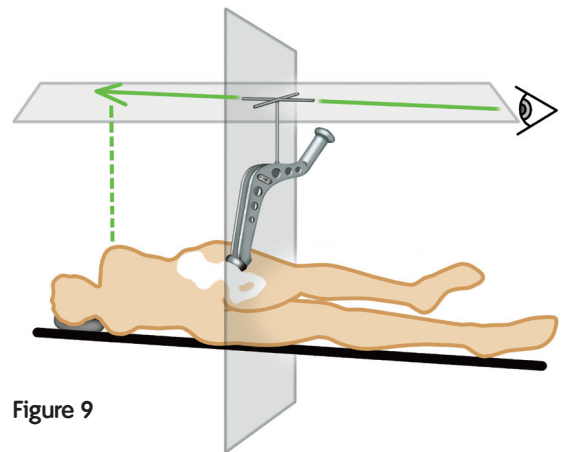

Figure 9

Surgical Tip

- Target acetabular component orientation for optimal bearing function;
 - 40-45° of abduction
 - 15-20° of anteversion
 - <45° combined stem/cup anteversion

Femoral Preparation

The desired position of the femoral alignment pin will be known from the Preoperative templating. Identify the tip of the greater trochanter through the tissues with a spinal needle.

A ruler is used to measure the desired distance down from the tip of the greater trochanter (Figure 1) and the alignment pin is inserted through the vastus lateralis fibres.

The front and back of the femoral shaft are felt and pin insertion is then started in a transverse direction into the mid-lateral cortex (Figure 2).

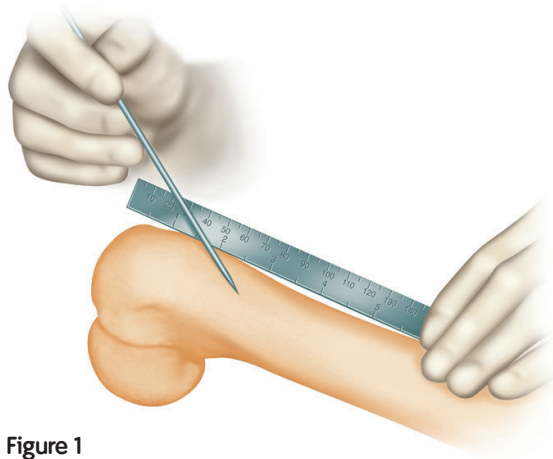

Figure 1

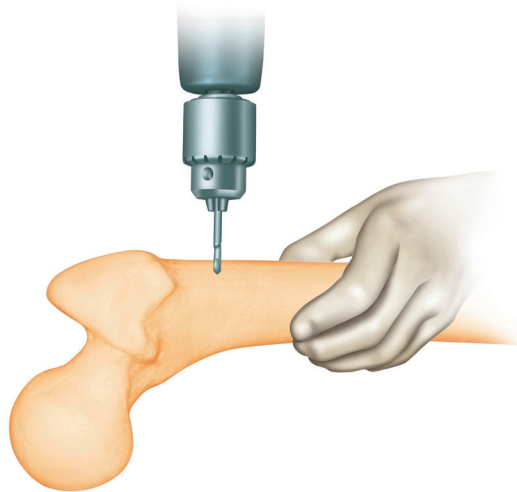

Figure 2

After the outer cortex is breached the drill is angulated so that the alignment pin is directed towards the femoral head (Figure 3).

The alignment pin is left protruding 5mm above the outer fibres of vastus lateralis.

Note: It is recommended that “Pin in Femur” is placed on the nurse’s swab count board.

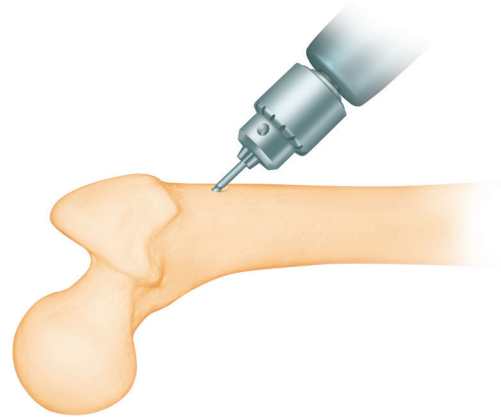

Figure 3

Using the McMinn Alignment Guide

The appropriate head implant size is set up on the head centre stylus. The alignment guide (Figure 4) is hooked onto the alignment pin and the leg fully internally rotated to deliver the femoral head into the centre of the wound.

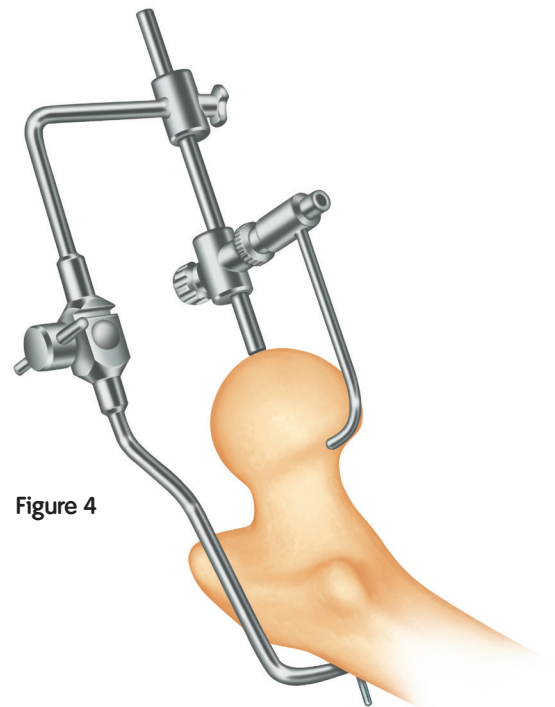

Figure 4

Using the McMinn Alignment Guide *continued*

The adjustable joint in the long arm of the alignment guide is set so that the guide wire will be directed down the mid-lateral axis of the femoral neck (Figure 5a). Bisect the neck with forceps to aid visualization (Not illustrated).

Next the proximal portion of the guide is moved on the femoral head to allow the stylus to be passed around the femoral neck, having first been set to the desired femoral component size (Figure 5b, 5c).

When the stylus can be passed around the femoral neck at an equal distance, then the central cannulated rod is locked into position by impacting the teeth on this rod into the femoral head. Thus the whole assembly is stabilized. Fine-tuning of this position can then occur.

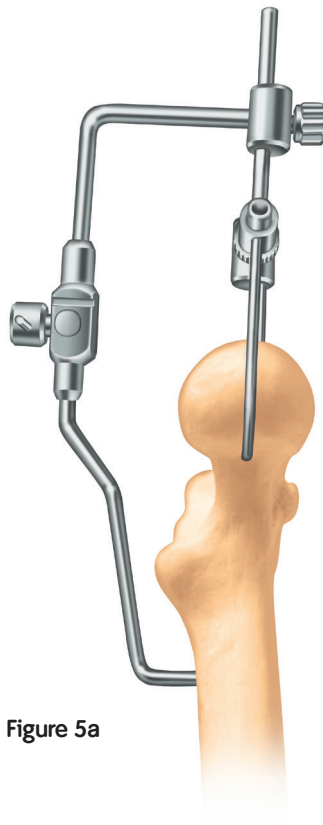

Figure 5a

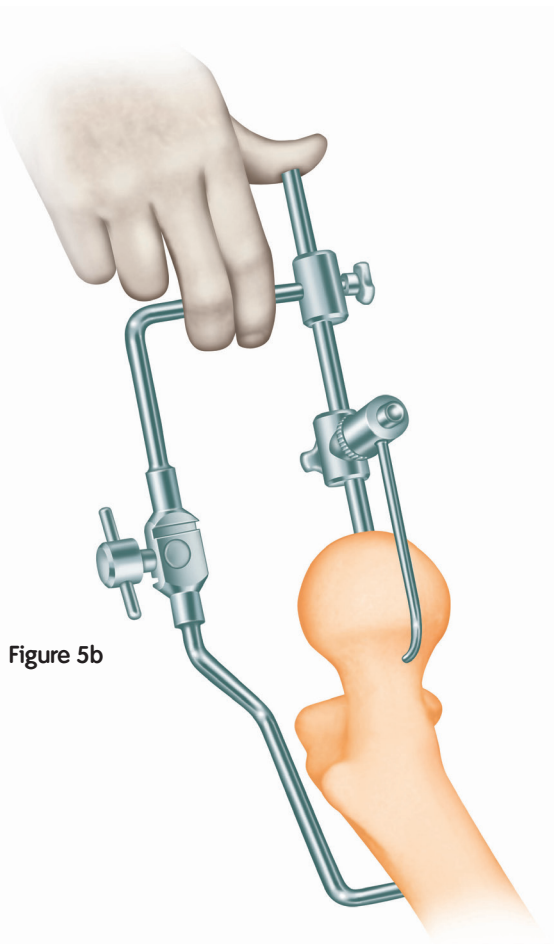

Figure 5b

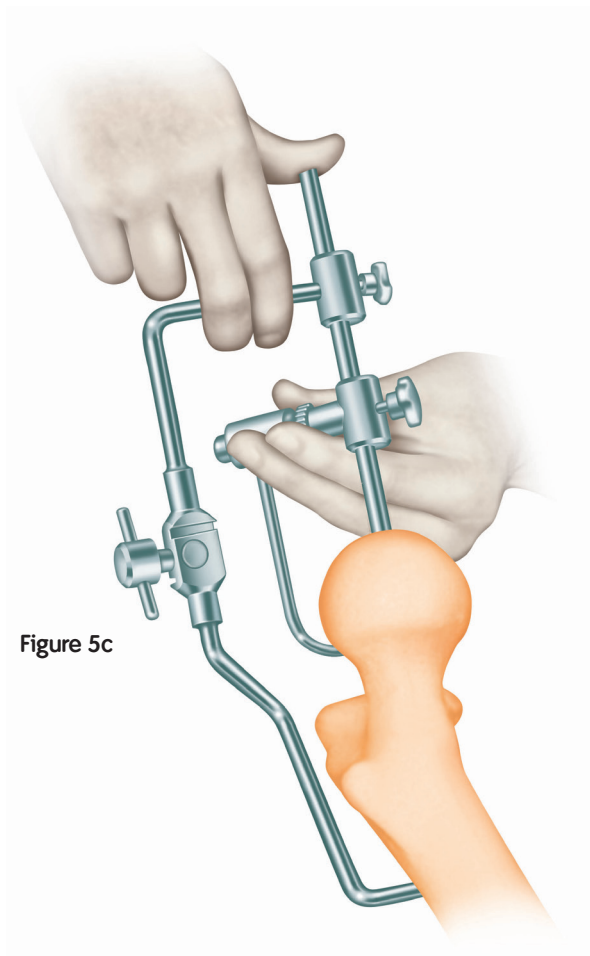

Figure 5c

Short Arm Alignment Jig Technique

Templating

BHR[®] template sets are used to determine component size and correct implant positioning. The position of the femoral component is a most important pre-operative consideration. Varus positioning must be avoided and slight valgus is recommended (Figure 6).

To achieve optimal femoral component positioning, place the appropriate BHR template onto the X-Ray. Once satisfied with the size chosen the medial head-neck-junction may be identified to set up the correct template positioning (A). This is aided by using the cut out section on the template which allows implant position markings to be made with the template in situ.

With the head-neck-junction identified the template is rotated around this point until desired valgus position is achieved with the implant's centre line. One limiting factor for implant positioning is the risk of femoral neck notching. This may be avoided at the templating stage by confirming there is no contact between the superior aspect of the femoral neck and the template (B).

When the desired template position has been achieved, the distance from the tip of the lesser trochanter to the centre line of the implant template is measured. The long axis of the ruler template (Figure 7) is overlaid with the centre line of the implant template to identify the pin insertion point on the intertrochanteric crest (C). This measurement is translated intraoperatively onto the patient's femur using the measuring guide (Figure 8) to achieve optimal pin, jig and ultimately femoral implant positioning. The pin insertion point may be marked using electrocautery or a medical needle to ensure optimal pin, jig and femoral positioning.

Note: To achieve correct measurement from the tip of the lower trochanter to the pin insertion point, the patient's leg must not be externally rotated while taking the X-Ray in supine position of the pelvis.

X-Ray magnification must be taken into account during this preparation.

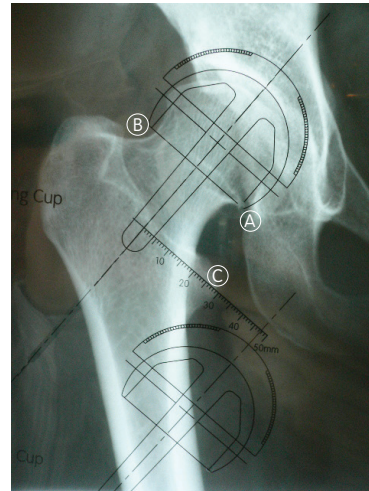

Figure 6

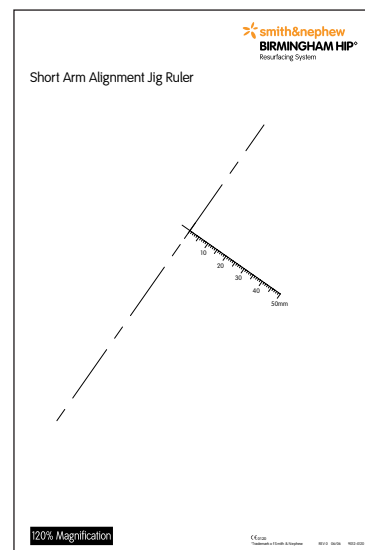

Figure 7



Figure 8

Short Arm Alignment Jig Technique *continued*

The measuring guide is placed on the tip of the lesser trochanter translating the Pre-operative measurement on to the intertrochanteric crest. The alignment pin insertion point can now be marked (Figure 9).

Using the marked insertion point on the intertrochanteric crest, the assembled jig is fixed to the femur by inserting the collared alignment pin through the hole in the distal slot of the alignment arm (Figure 10).

Note: Care should be taken to use the correct collared alignment pin as this differs from the item used with the traditional long arm jig.

The alignment jig can now be used to correctly position the long guide wire and ultimately achieve correct implant positioning (Figure 11).

The operation of the short arm jig remains consistent with the traditional McMinn alignment jig as described earlier in this BHR[®] Surgical Technique .

On correct positioning of the long guide wire the alignment guide assembly is released from the femur by first removing the collared pin.

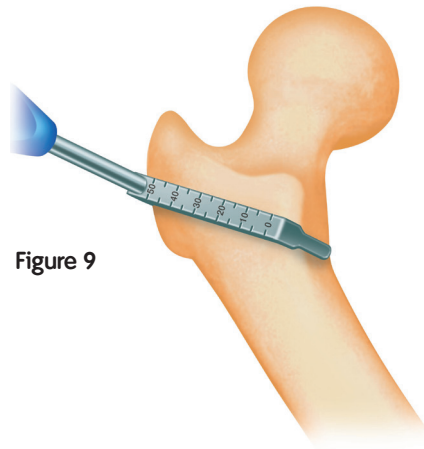

Figure 9

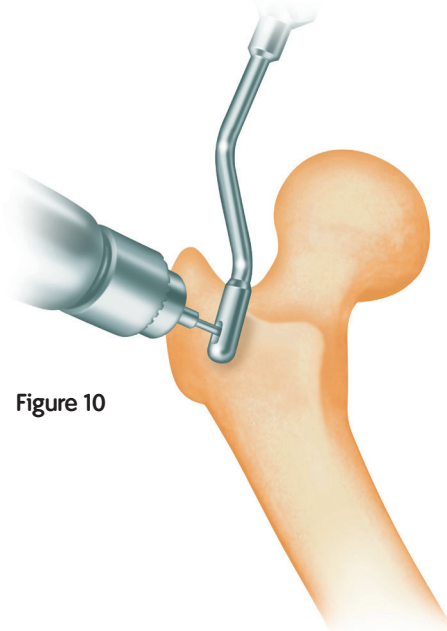

Figure 10

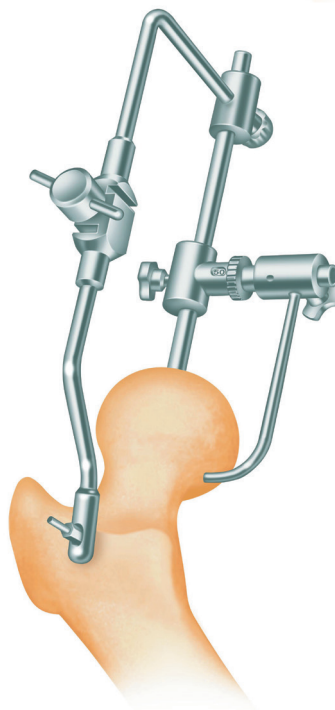

Figure 11

A guide wire is inserted when the desired position of the alignment guide has been achieved. (Figure 12). The central rod is removed and the guide assembly completely removed.

Note: Guide wires are intended for single use only. Re-use of the guide wires may lead to breakage.

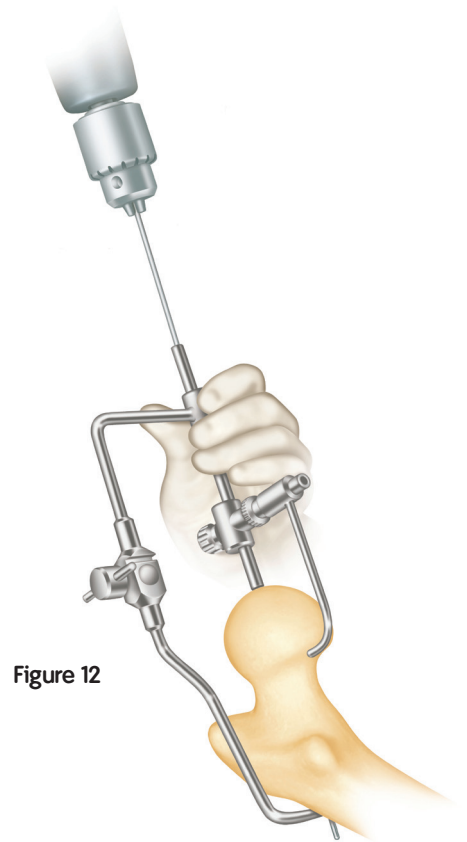

Figure 12

The stylus is re-inserted on the guide wire and a final check made to ensure that the stylus passes comfortably around the femoral neck (Figure 13).

Note: A re-drill guide is available for the correction of minor alignment errors (not illustrated).

Secondly, a check is made to ensure that when the sleeve cut is made some peripheral femoral head support exists. This is not only important with respect to support for the implant, but is very important with respect to the pressurization of cement. Care must be taken in cases of slipped epiphysis, or in pistol-grip deformity where the femoral head is not symmetrically located on the femoral neck.

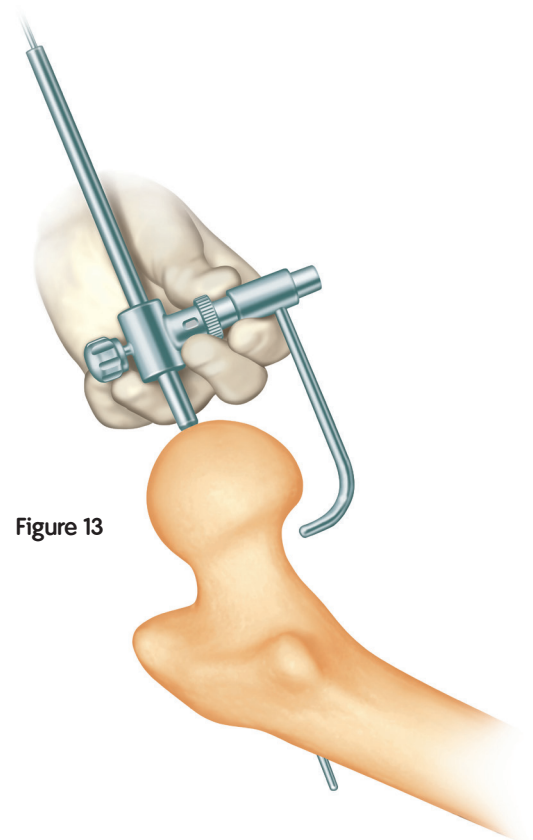

Figure 13

When the desired position of the guide wire has been achieved then the guide wire is overdrilled to the appropriate depth for the implant being inserted (Figure 14).

At this stage a hole is drilled and the vent is inserted into the lesser trochanter and connected to the second suction device (not illustrated). The guide wire is removed and the guide rod inserted (Figure 15).

The most stability is achieved when the thicker lower aspect of the guide rod is placed flush with the bone (Figure 16).

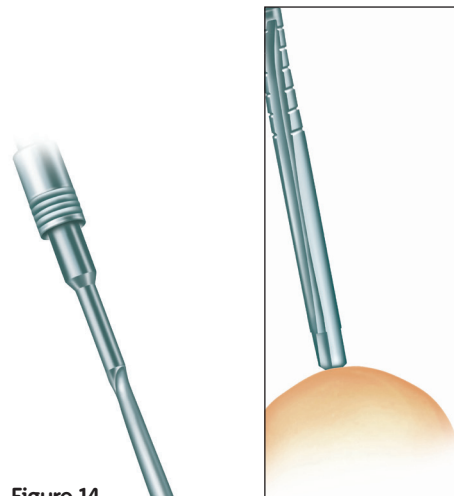

Figure 14

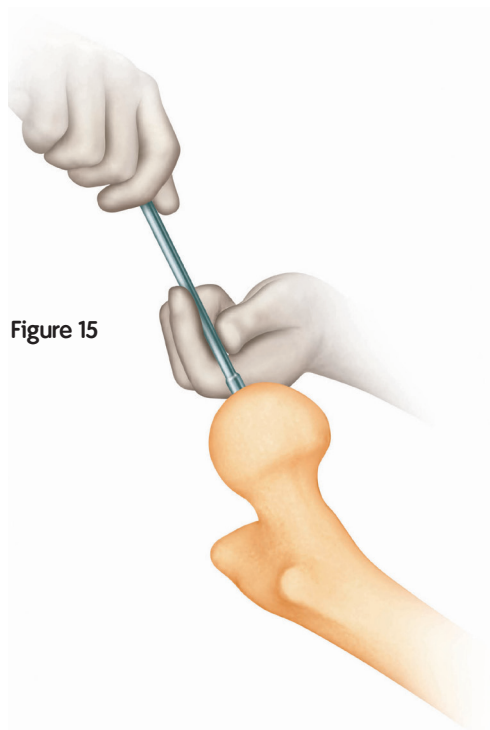
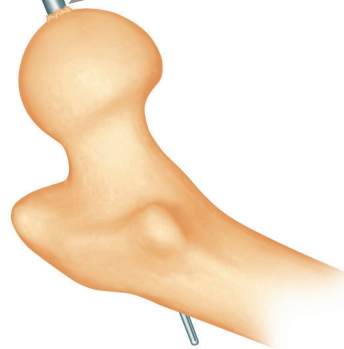

Figure 15

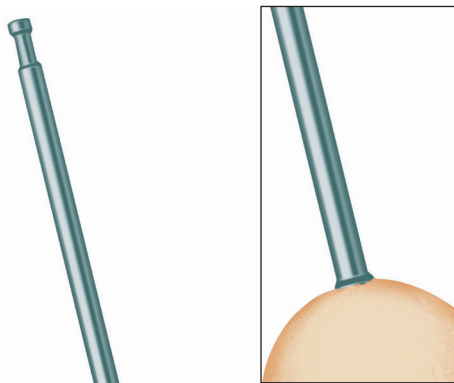

Figure 16

Using the Sleeve Cutter Stop

Smith & Nephew have developed the BIRMINGHAM HIP® Resurfacing (BHR®) Sleeve Cutter Stop to reduce the risk of 'shoot through' and therefore femoral neck notching while preparing the femoral head.

This is achieved by providing a physical method of controlling the distance the sleeve cutter can travel when preparing the femoral head. The sleeve cutter stop stylus allows the surgeon to visualize the sleeve cutting diameter and depth on the patient's femoral neck before performing the sleeve cut.

The sleeve cutter stop stylus is used over the guide rod which has been inserted into the pre-drilled femoral head.

The appropriate head implant size and therefore sleeve cutter is set up on the sleeve cutter stop stylus. This is done in two ways; the first is to set the size using the thumb wheel this allows the chosen size to be read through the stylus window (Figure 17).

Secondly the stylus arm is set by moving it up or down within the body of the stylus until the correct size is shown on the scale along the top side of the stylus body (Figure 18)

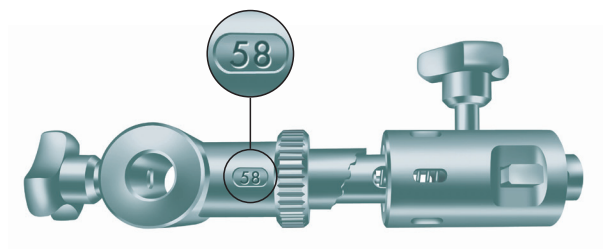

Figure 17

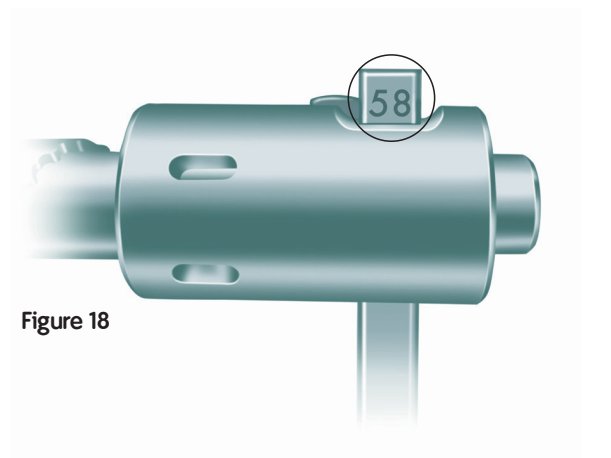

Figure 18

Using the Sleeve Cutter Stop *continued*

The sleeve cutter stop stylus is placed on the guide bar. The stylus arm is passed over the femoral head. It is the superior aspect of the femoral neck which is most prone to notching or 'shoot through' therefore this should be the starting point for positioning the tip of the stylus arm (Figure 19).

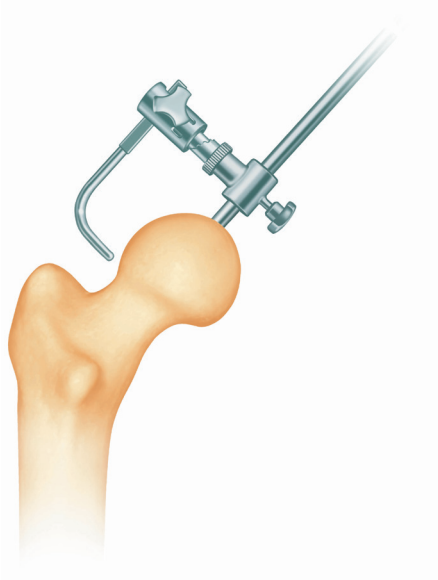

Figure 19

The positioning of the tip of the stylus denotes the depth the sleeve cutter will cut to (Figure 20)

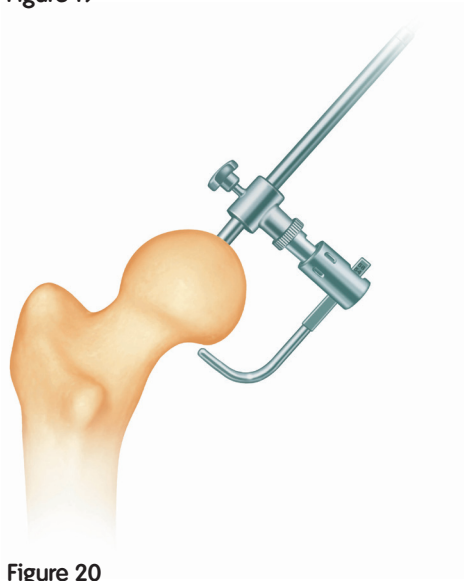

Figure 20

The tip of the stylus arm should be in contact with the femoral head but remain in clearance of the femoral neck.

The thumb screw is then tightened against the guide bar to set the chosen depth.

The stylus should now be passed around the femoral neck to confirm the chosen depth is accurate. (Figures 21 and 22)

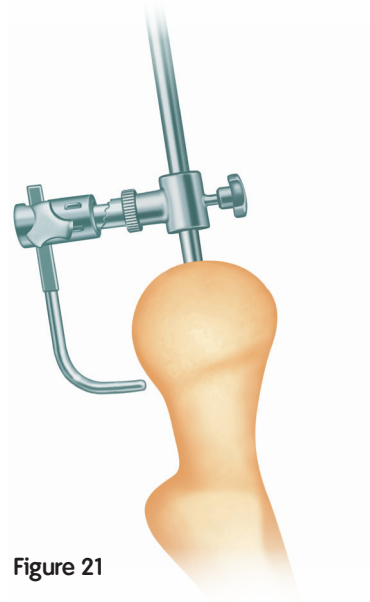

Figure 21

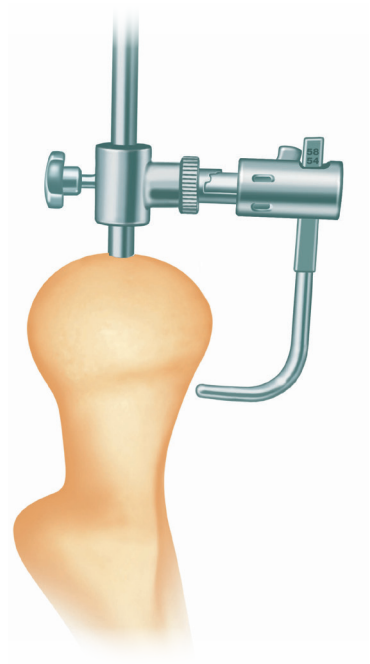

Figure 22

When satisfied with the chosen cutting depth a sleeve cutter stop spacer is selected. The correct size of spacer is determined by the space in between the base of the instrument and the top on the femoral head. This is achieved using two methods; the spacers may be placed into the space until the desired size is selected (Figure 23). Alternatively a ruler may be used to measure the space and then the corresponding sized spacer selected. 6 spacers are provided 10, 12, 14, 16, 18 and 20mm.

The sleeve cutter stop is now removed from the guide bar. The selected spacer is then placed onto the guide bar until it is in contact with the femoral head (Figure 24). The sleeve cutter stop may then be placed over the guide bar and advanced to the top of the spacer. The stylus is now passed around the femoral neck to confirm the intended cut depth is correct and no neck notching should occur. When satisfied the sleeve cutter stop stylus is removed from the guide bar and the spacer left in place.

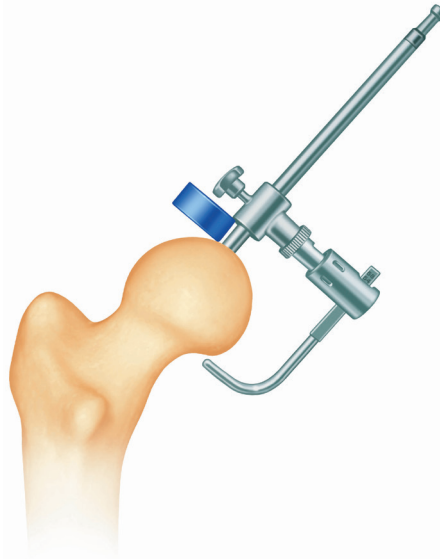

Figure 23

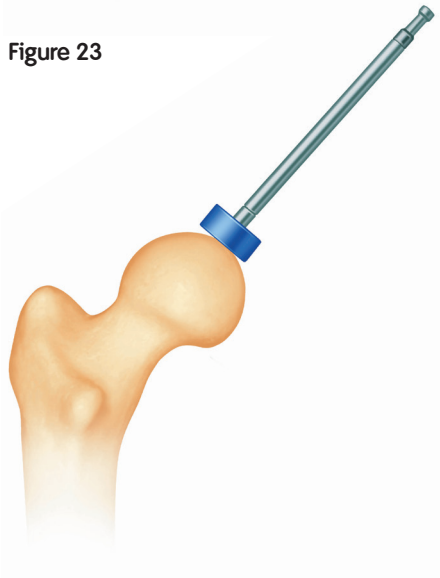

Figure 24

Before femoral head preparation, the base of the femoral neck is packed with wet swabs to prevent bone debris entering the peri-articular soft tissues. However it is important to keep these swabs clear of the head so that they do not catch in the femoral cutter instruments.

The head/neck template is then positioned on the superior femoral neck as a second safe guard, to protect the head/neck junction in the event of 'shoot through' (Figure 25).

The appropriate sleeve cutter is advanced. This should be done slowly and with care to ensure that 'shoot through' does not occur and also to ensure that femoral neck notching is not occurring. It should be noted that in most osteo-arthritic femoral heads an eccentric amount of peripheral femoral head is regularly removed.

NOTE: The assistant is key in keeping the femoral head in the centre of the wound.

The sleeve cutter is advanced until it comes up against the spacer and cannot be advanced further (Figures 26 and 27). The sleeve cutter stop spacer is now removed.

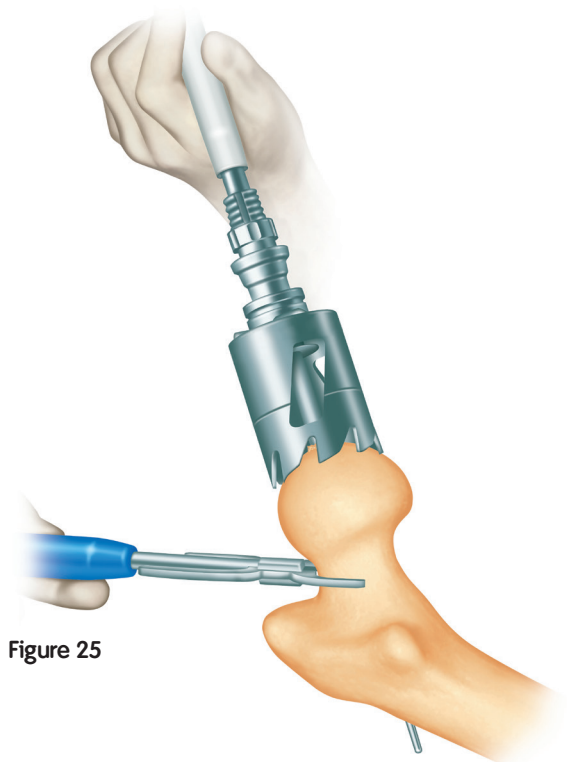

Figure 25

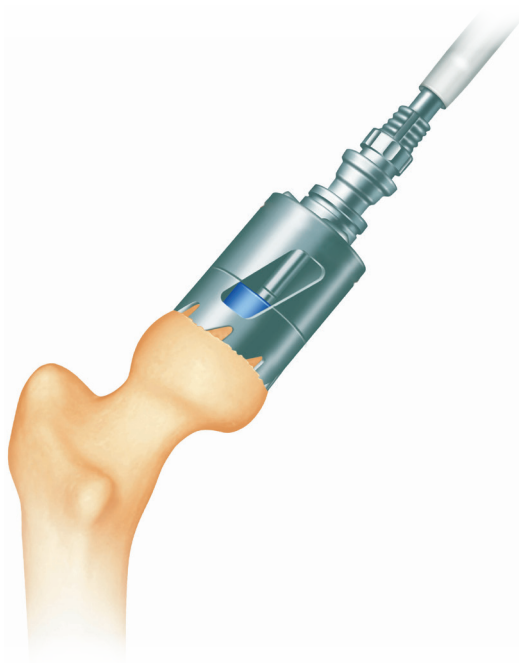

Figure 26

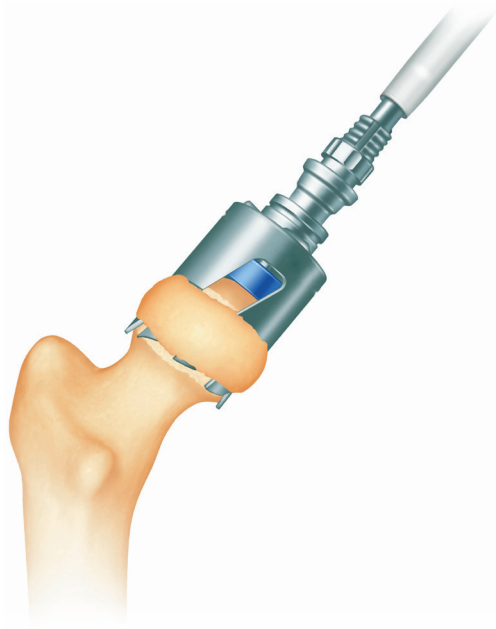

Figure 27

The peripheral bone and any head/neck osteophytes should be trimmed off taking care not to strip any soft tissue attachments from the femoral neck (Figure 28, 29).

The guide rod is pushed down the femur by hand until it is seated at the bottom of the prepared hole and left in its final position (Figure 30). **NOTE: Care should be taken that the thick aspect of the guide bar is now seated below the surface of the bone, as the thick aspect of the guide bar can act as a stop when using the plane cutter.**

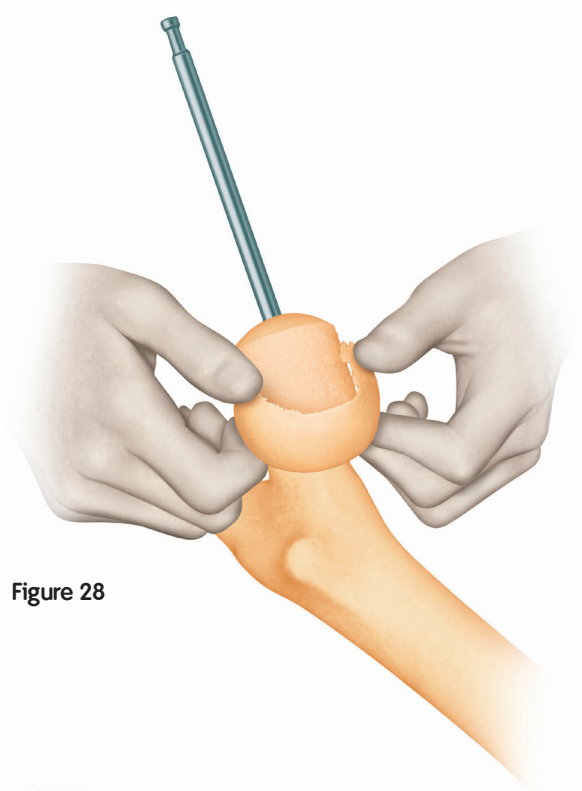

Figure 28

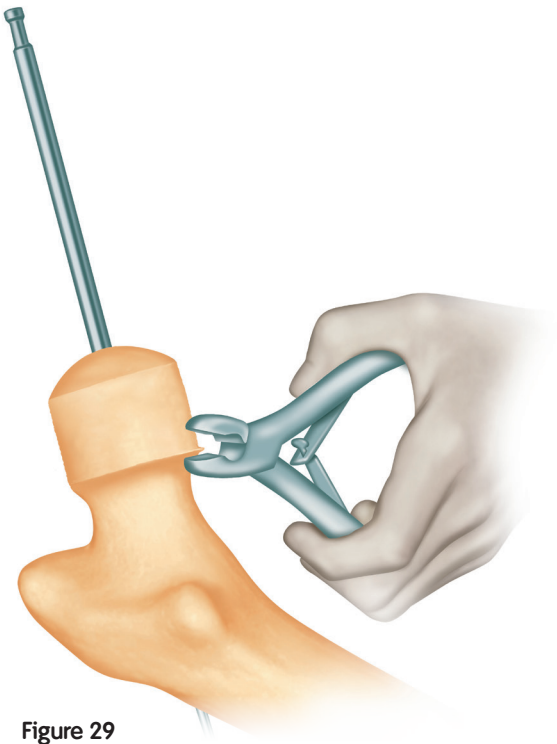

Figure 29

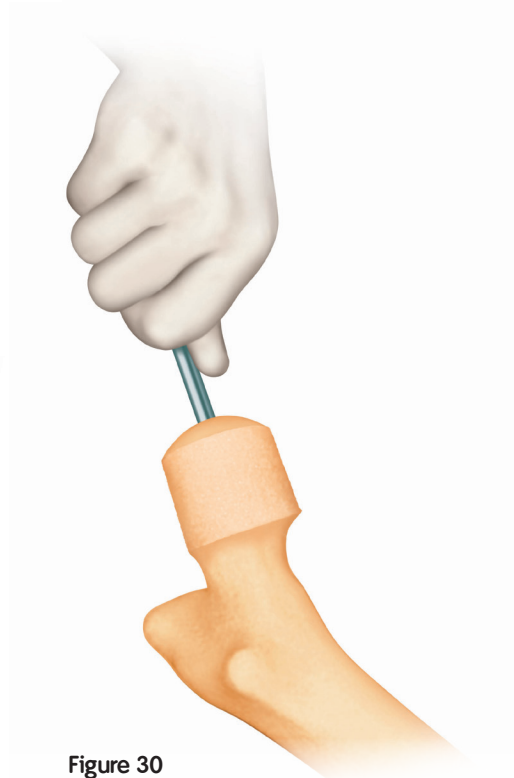

Figure 30

Note: Various methods of templating the desired amount of proximal bone to be removed may be employed.

The sleeve cutter is advanced by hand over the previously prepared femoral head until the teeth meet the medial femoral head/neck junction (Figure 31). Once in correct position, a surgical marking pen is used to mark the resection line on the bone surface through the 'window' in the sleeve cutter. Alternatively, the appropriate head/neck template is advanced over the prepared femoral head until the lower aspect meets with the medial head-neck junction. The surgical marking pen is used to mark the resection height which is indicated on the scale of the device (Figure 32).

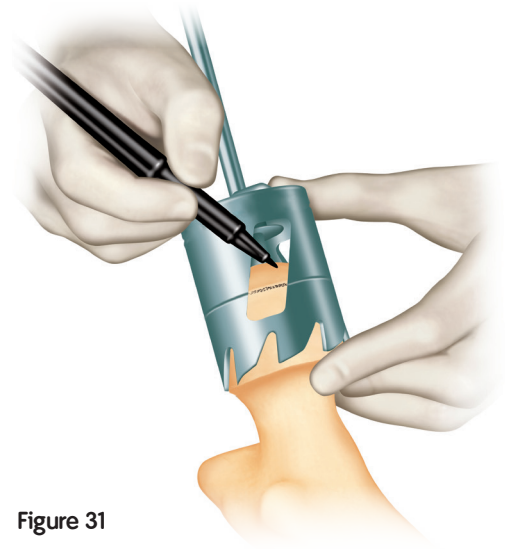

Figure 31

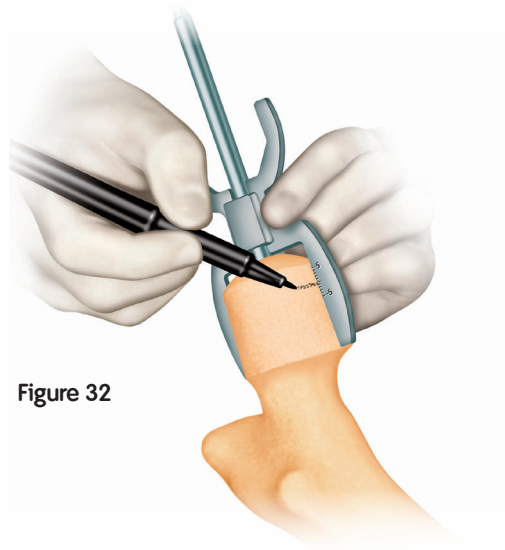

Figure 32

The Plan Cutter is then advanced over the guide rod stopping at the marked resection line (Figure 33). Identify the marked resection line with the guide wire to aid visualization.

To ensure correct bone resection, the head-neck template is to be advanced over the guide rod. Meeting the medial head-neck junction, bone has to point to the neutral (0) position of the device (Figure 34).

The appropriate chamfer cutter is used (Figure 35). It will usually be the case that the eccentricity of the femoral head disappears after chamfer cutting. Great care needs to be undertaken when using this instrument as considerable torque can be generated by the mixture of sclerotic and normal bone in the femoral head, so the instrument is advanced lightly and with regular irrigation. Experience has shown that high speed is advantageous and the powerdriver is set on drill rather than ream, thus giving high speed and low torque.

Note: It is recommended to start all power tools away from bone before advancing over the guide rod. This keeps torque and stress to a minimum.

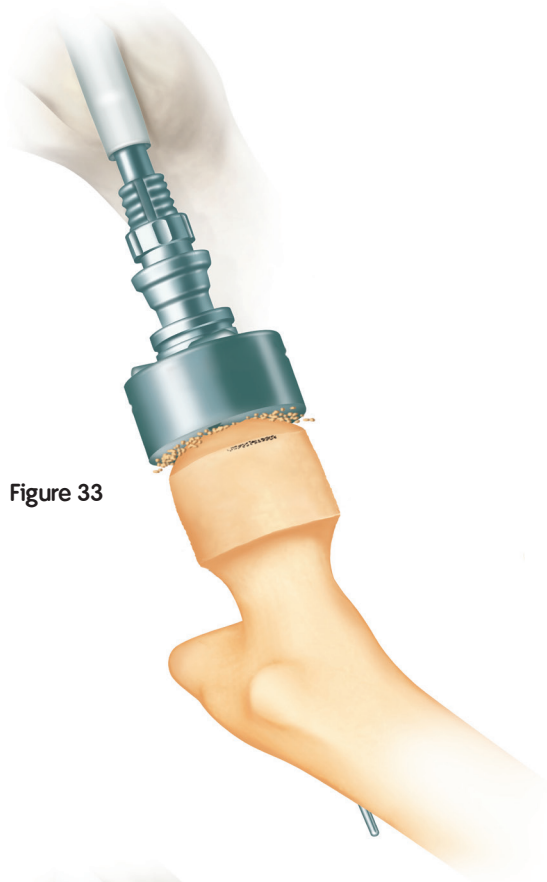

Figure 33

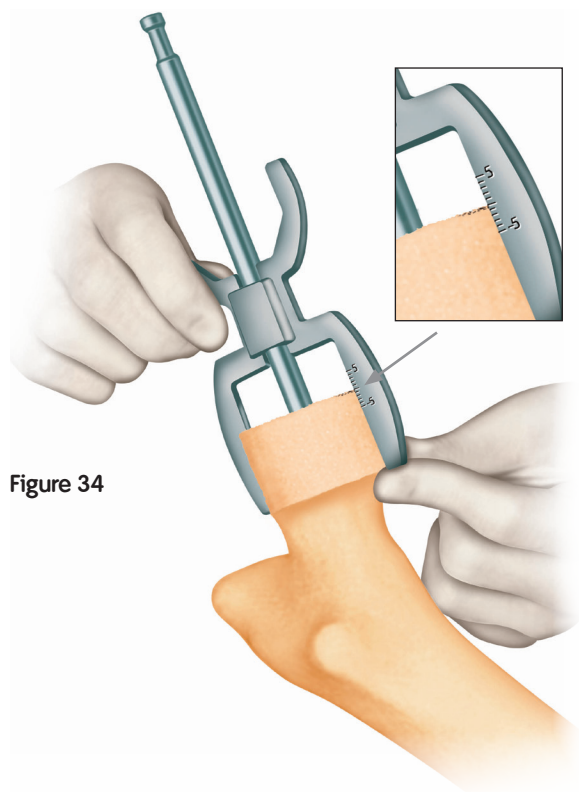

Figure 34

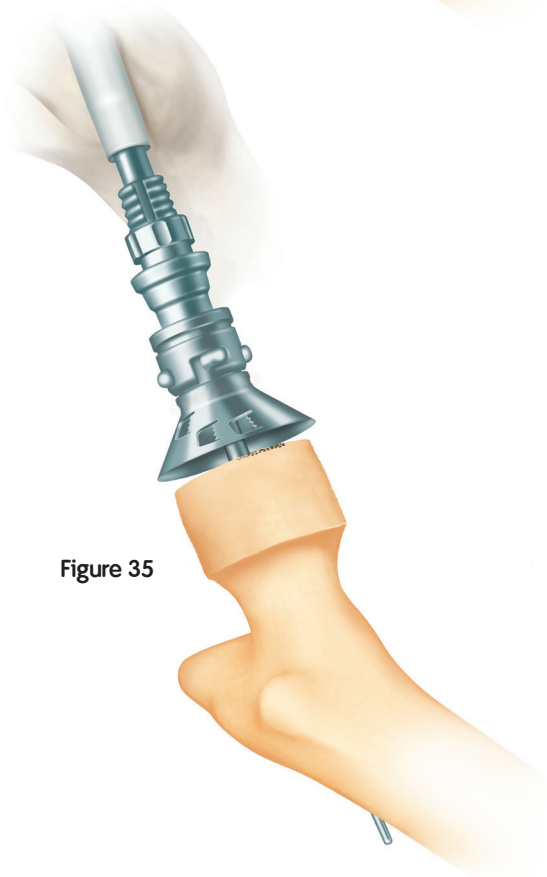

Figure 35

A number of cement keyholes are drilled into the femoral head using the Wroblewski drill (Figure 36). At this stage any cysts are curetted. If the defects are relatively small, they are left and will be filled with cement. If the defects are substantial, they may be grafted with acetabular reamings prior to cementation.

The femoral head is thoroughly lavaged and brushed to open the cancellous network (Figure 37). With maximum rotation on the femur, the suction vent is inserted into the lesser trochanter (Figure 38). The femoral head can usually be kept free of blood until cementation occurs.

Note: Care should be taken when using the suction vent. Excessive use or force may result in damage or breakage.

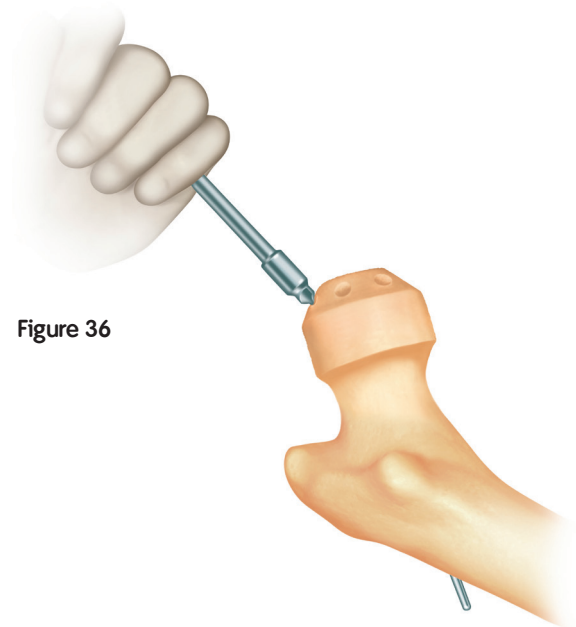

Figure 36

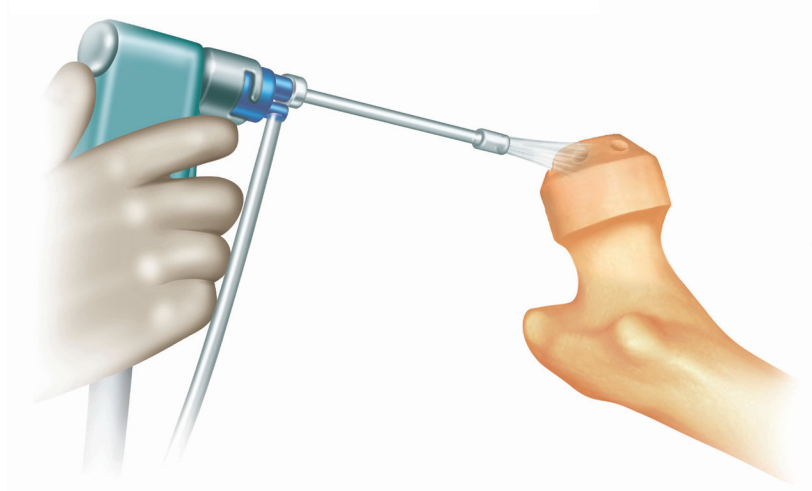

Figure 37

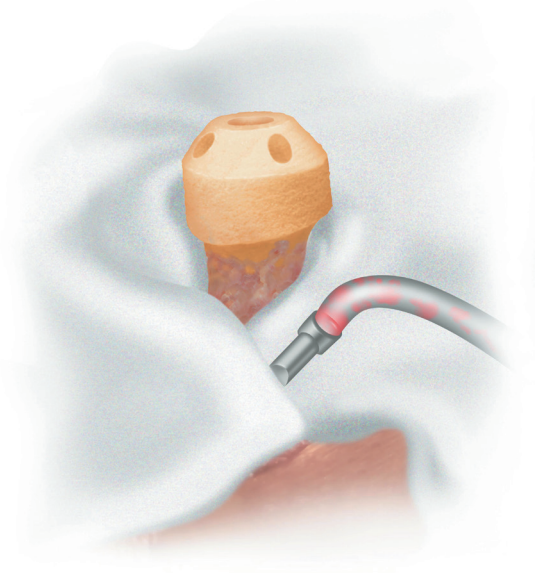

Figure 38

Using the Stem Drill

The appropriately sized stem drill (tapered reamer) is used to enlarge the parallel hole to suitably fit the tapered stem of the femoral component. There are two sizes of stem drill (tapered reamer) which correspond to sized groups of femoral components as follows:

Size 2 = 48-52

Size 3 = 54-62

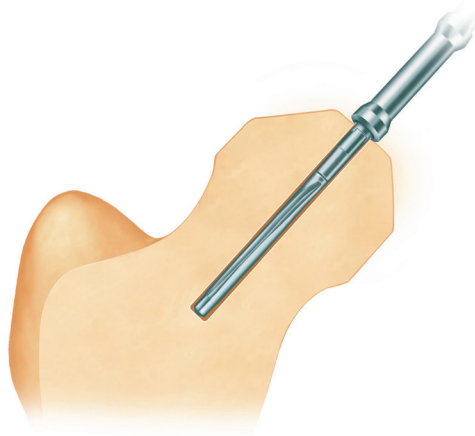

Figure 39

A mark is made on the femoral head-neck junction using the appropriate head-neck template over the guide rod (Figure 40) and surgical marker pen or electro-cautery to determine how far the prosthetic femoral head component should be advanced. Impacting the prosthetic head to this mark ensures optimum pressurization of cement into the open cancellous network, gives good support for the implant and ensures, as far as possible, the correct leg length. The guide bar is then removed. Low viscosity cement is mixed and poured into the head implant. Alternatively, it can be drawn up into a bladder syringe and injected into the femoral component (Figure 41).

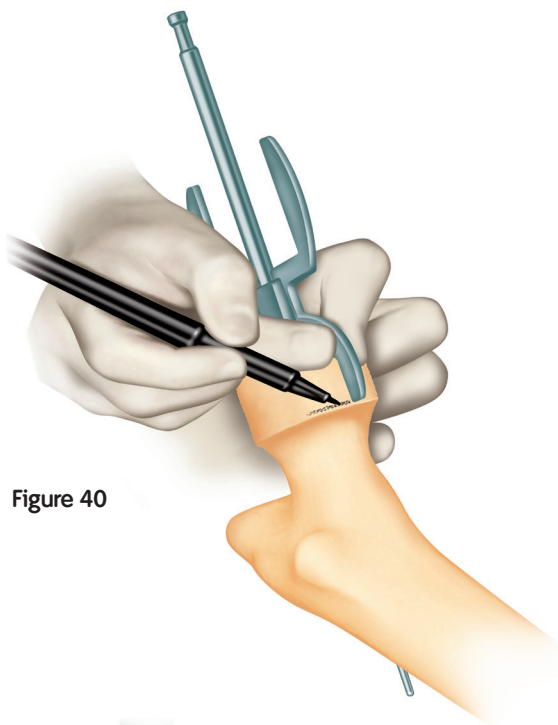

Figure 40

Note: Low viscosity cement in sufficient quantity is used. High viscosity cement will prevent correct femoral component seating.

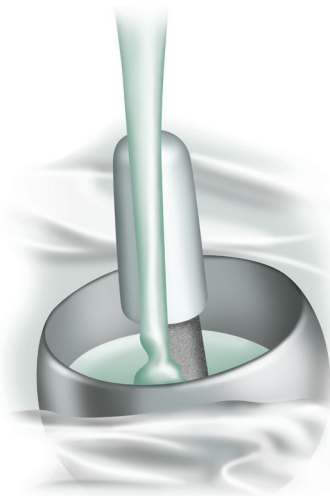

Figure 41

One minute after the start of cement mixing, the femoral component is impacted into position to the previously made mark (Figure 42). It is important to have a swab positioned anteriorly to collect any extruded cement and to prevent this from flowing into the acetabular component. It is important not to get this swab caught between the femoral component and bone.

All extruded cement at the periphery of the femoral component is removed. Any remaining osteophytes at the femoral head-neck junction are excised (Figure 43) and the femoral head thoroughly cleaned with wet swabs and pulse lavage. The acetabular component is also thoroughly cleaned with pulse lavage and preparations made for reduction.

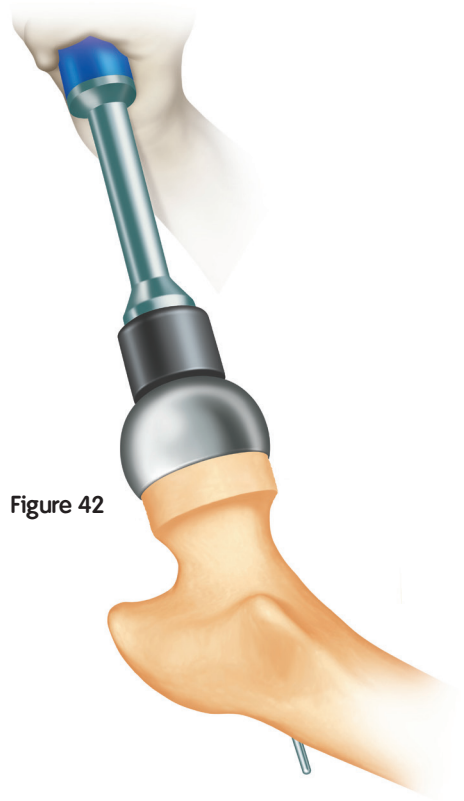

Figure 42

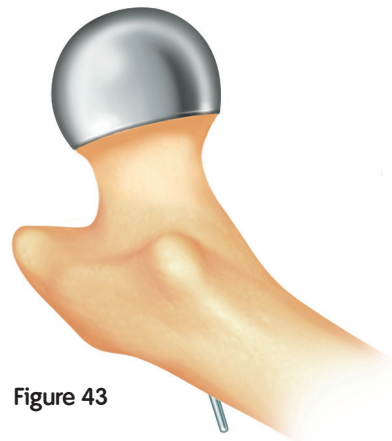

Figure 43

Using the Stem Drill *continued*

When traction and rotation are applied to the femur the femoral component can be clearly located in the acetabular component. Scratching the femoral component against the edge of the acetabular component should be avoided and without trapping any capsule or synovial tissue between the femoral head and the acetabular component. A check is made to ensure that no entrapment of soft tissue has occurred between the reduced components and a check is also made for stability and range of movement.

The femoral alignment pin is removed from the lateral femoral cortex (Figure 44) and the wound closed in layers using nylon for the fascia lata.

Note: It is vital to remove the alignment pin from the femur and this should be recorded on the swab board.

The patient is mobilized full weight bearing the following day and sticks abandoned between one and three weeks after operation as confidence and a normal gait allow.

Patients are allowed to sit on a normal height toilet seat or chair and sleep on their unoperated side as desired.

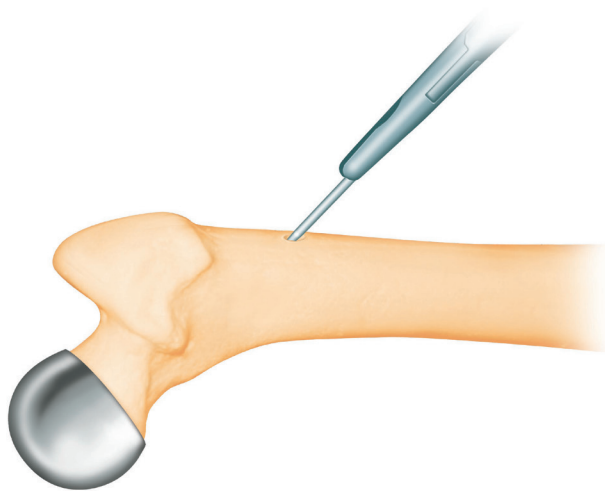

Figure 44

Size Chart

The size charts (available as a wall chart for classic sizes and combined sizes) are presented to remind the surgeon of the femoral head and cup sizes that can be matched (Figure 45).

For example, the size 50mm femoral component can be matched with a size 56mm acetabular cup, a size 58mm acetabular cup, or size 58mm dysplasia cup. All these components have red coloured labels on their boxes.

**Never mix colors on heads and cups.
Compatible femoral and acetabular components are all the same color.**

BHR® Implant Size Chart		smith&nephew BIRMINGHAM HIP® Resurfacing System	
HEAD SIZE	CUP SIZE	DYSPLASIA CUP SIZE	
48	54 56	56	
50	56 58	58	
52	58 60	60	
54	60 62	62	
56	62 64	64	
58	64 66	66	

IMPORTANT: NEVER mix colours on heads and cups.
**Trademark of Smith & Nephew 06/15 04/09

Figure 45 – Implant Size Chart Classic Sizes

Dysplasia Cup

Where there is an obvious superolateral deficiency of the acetabulum, the option exists for the use of the BHR[®] Dysplasia Cup which uses a unique screw fixation to stabilize the acetabular implant. The acetabulum should be reamed in the true hip centre position. In severe dysplasia it is desirable to bias the acetabular reamers in a posterior direction, to thin the thickened posterior acetabular wall and preserve the deficient anterior acetabular wall. It is recommended to deepen the acetabular floor to the inner table to gain maximum superior cover in dysplasia. On occasions a slightly high hip centre will give enough support for a regular spherical cup. If there is not enough superior support for a spherical cup then the options are either augmentation of the acetabular roof with a structural allograft or the use of a BHR dysplasia cup and morcellised autografting of the acetabular defect.

In order that the screws engage bone, the dysplasia cup should be rotated anteriorly (not anteverted) from the neutral position (Figure 1). The cup is impacted to the floor of the acetabulum.

Note: Do not cut the cables at this stage.

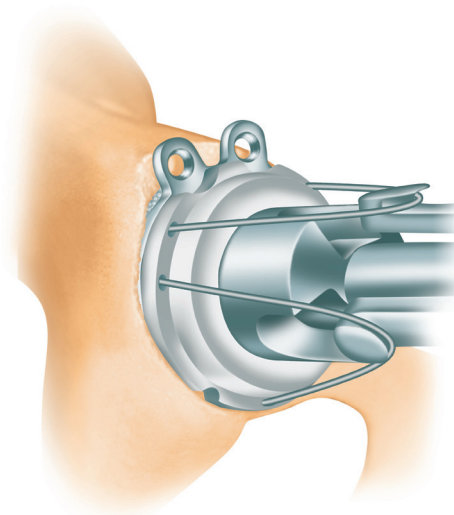

Figure 1

Retract the polyethylene impactor cap and ensure satisfactory cup position. Always drill the posterior lug first as this is the drill hole most likely to miss the posterior ilium (Figure 2). If this happens, re-apply the cup introducer and reinsert the cup with more anterior rotation. Please note that excess anteversion and an excessively closed position of the acetabular component increase the chances of the posterior drill hole missing bone.

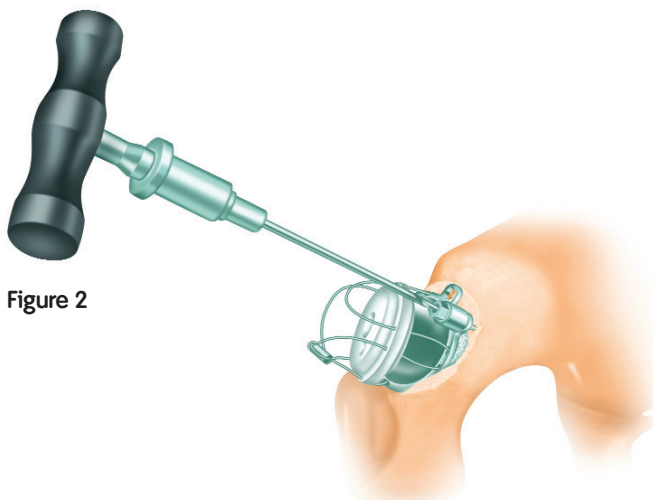

Figure 2

The pilot drill guide should then be screwed into the posterior lug and a 3.2mm drill passed to the inner cortex.

If the cup is positioned satisfactorily the pilot drill guide is then removed and the larger dysplasia screw drill is used to over-drill this hole through the lug, opening the canal to the screw core diameter. A depth gauge is used to gauge screw length. In severe dysplasia maximum screw length is desirable. In less severe dysplasia shorter screws can be used. Please note: these screws are neutralization screws, they are not compression screws and if inserted correctly they are not distraction screws.

A BHR® dysplasia self-tapping screw of appropriate length is then threaded through the lug using the socket provided and the screw driver handle (Figure 3). When the screw reaches the bone longitudinal compression is applied as the screw engages the bone, thus preventing the cup from being pushed out of the acetabulum.

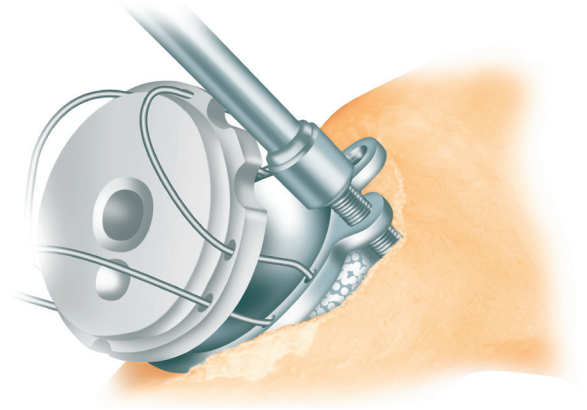

Figure 3

Dysplasia Cup *continued*

Once the screw is securely fixed in bone then power may be used to drive the screw home. This requires the high torque ream setting.

Final tightening is applied using the 'T' Handle and the screw head should sit flush on the lug face. The final tightening is engineered deliberately tight to prevent screw back out. The sequence is then repeated with the anterior lug (Figure 4). When both screws have been inserted the cables are cut and the polyethylene impactor cap removed. The false acetabulum is cleared of all soft tissue with a curette and the bone petalled with a gouge. The defect is grafted by impacting reamings into the defect between the cup and false acetabulum. This is then covered with surgical mesh for stabilization.

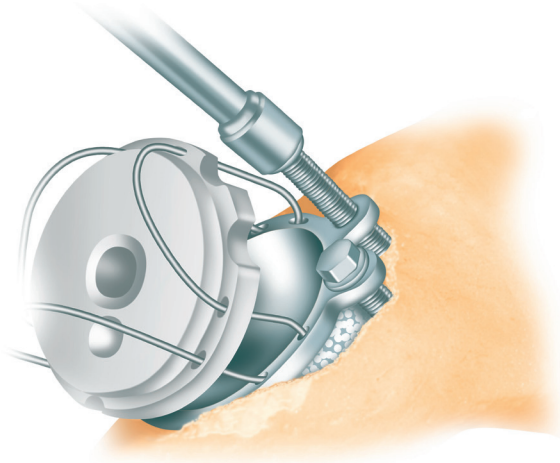

Figure 4

With acetabular dysplasia the surgeon has to exercise judgement regarding the post-operative weight-bearing regime. In severe dysplasia we recommend keeping the patients partial weight-bearing, using elbow crutches for six months, but in less severe dysplasia full weight-bearing is permitted from the first post-operative day.

A typical regime for moderate dysplasia is partial weight bearing using elbow crutches for six weeks, followed by two sticks with gradually increasing activity over the next six weeks. We now have histological evidence of impressive bone ingrowth into the hydroxyapatite coated POROCAST[®] bone ingrowth cup surface at six weeks. However, in severe dysplasia we recommend to see radiographic evidence of bone graft incorporation in the false acetabulum before allowing the patient to become fully active.

Additional screw fixation of the acetabular component by utilizing the dysplasia cup may be desirable in certain non-dysplastic acetabulae. In these non-dysplastic acetabulae, the edge of the superior acetabulum impinges on the lugs, thus preventing complete seating of the acetabular component. Therefore, the operating surgeon may utilize a surgical burr to facilitate placement of the lugs without compromising the acetabular orientation.

Thrombo-embolic Prophylaxis

It seems clear that thrombo-embolism is much more of a problem following hip arthroplasty than with any type of soft tissue surgery. It is obvious that some factor in addition to venous stasis and endothelial damage is at work. This factor is bone marrow and fat embolization caused by the insertion of a femoral component, particularly a cemented femoral component.

During preparation of the upper femur and insertion of a cemented THR femoral component, pressures up to 1400mm Hg have been measured in the distal femur. These very high intramedullary pressures displace marrow and fat into the venous circulation. During hip dislocation from all surgical approaches the femoral vein is kinked and it is not until reduction of the prosthetic head into the acetabular component that marrow and fat gush into the right heart and pulmonary circulation.

Application of the cemented femoral component of the BIRMINGHAM HIP® Resurfacing (BHR®) System also raises the femoral intra-medullary pressure, but the amount of fat displaced is much less than with a cemented stemmed THR.

In an effort to prevent the small amount of fat displacement known to occur with resurfacing, use a method of suction venting of the femur during femoral preparation and component insertion. A hole is drilled through the lesser trochanter and a cannula is inserted into the centre of the femoral canal. This is attached via extension tubing to a second suction unit. During insertion of the cemented femoral component there is an impressive amount of fat and marrow removed from the femur (Figure 1).

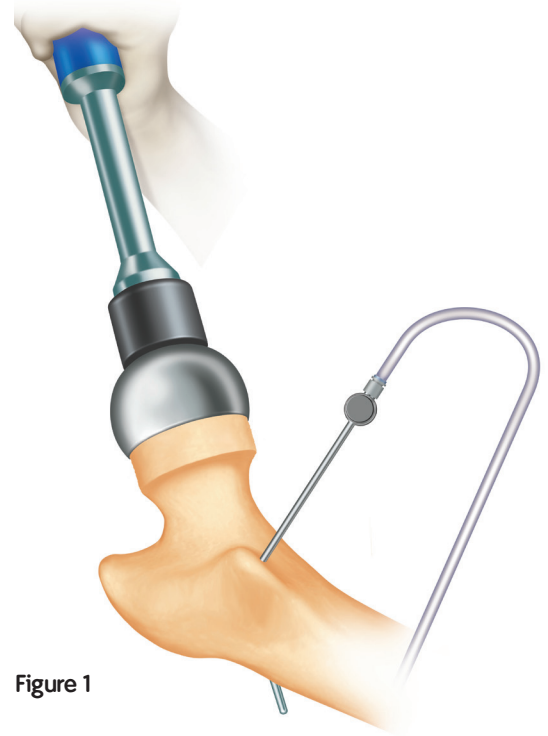

Figure 1

Acetabular Cup Extraction Kit (Cat. no. 900-201)

Instruction for Use

Intended Use

The Acetabular Cup Extraction Kit is intended for use to remove acetabular components of the BIRMINGHAM HIP® Resurfacing device during revision operations.

Sterility

The Acetabular Cup Extraction Kit is provided sterile for SINGLE USE ONLY. The sterilization method is gamma irradiation with a minimum of 25 kGy and a maximum of 35 kGy. The Acetabular Cup Extraction Kit must not be resterilized by the user.

Mixing of Components

This kit should never be used in conjunction with other manufacturer's implants or instruments.

Indications

The indication for use of this kit includes all revision operations where revision of the BHR acetabular cup is necessary.

Contraindications

None.

For more information on the BIRMINGHAM HIP Resurfacing System please see the General Information Leaflet enclosed with each implant and the operative technique.

Introduction

To extract an implanted Smith & Nephew BHR Acetabular Cup, a cable must first be threaded through the 3 wormholes and joined with a metal collar using a special knot. This provides three loops of cable for the extraction/impaction tool to attach to via a plastic spacer. The cup can then be manipulated or hammered out using a slide hammer.

Instructions

Two types of cable are supplied with the extraction kit, a plastic coated cable and an uncoated cable. As a first attempt, lace the acetabular cup with the plastic coated cable. Thread the cable through the worm holes leaving loops large enough to fit over the impaction / extraction tool with the plastic spacer attached, shown in Figure 1.

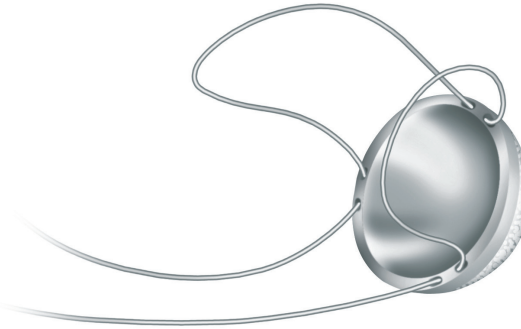

Figure 1

For convenience the knot should be tied without the extraction tool in place. Pass the cable ends through the metal collar, as shown in Figure 2, leaving approximately 5cm (2") of the free ends protruding.

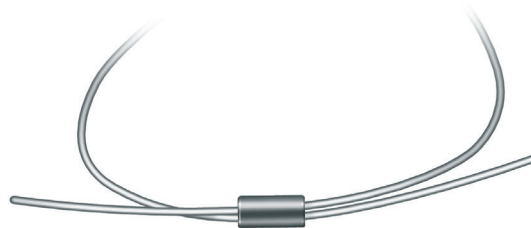

Figure 2

Pass each end back through the metal collar to form small loops, just large enough to pass the cable through. (Figure 3a and 3b). Ensure that there is approximately 4cm (1.5") of free cable end after it has been passed through the metal collar.

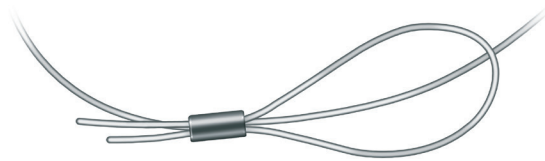

Figure 3a

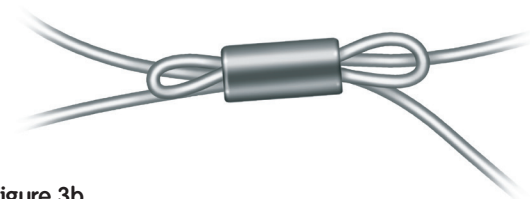

Figure 3b

Pass each free end over the metal collar and back through its own loop (figures 4a and 4b). It may be necessary to pinch the cable down onto the metal collar in order to keep the cable ends within the loops. The knot is now formed and ready to be tightened using the extraction tool.

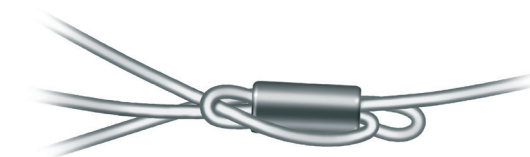

Figure 4a

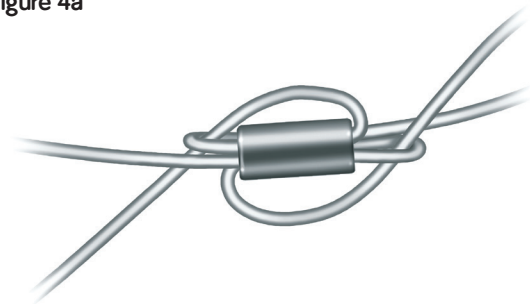

Figure 4b

Once the knot has been formed attach the plastic spacer to the extraction tool and insert the extraction tool into the acetabular cup. Pass the cable loops over the ends of the extraction tool. It may be necessary to adjust the cable lengths to ensure that the cable loops pass over the tool and plastic spacer. It may also be necessary to reposition the knot, so that it lies mid way between the extraction tool and the acetabular cup. Slowly begin to tension the cable loops. As this is done, the knot will begin to tighten. During this process, ensure that the spare cable has been pulled through the loops and that the cable is flush to metal collar. Continue to tighten until the knot is secure. The cup can now be extracted by attaching a slide hammer to the extraction tool. During extraction it may be necessary to re-tension the cables.

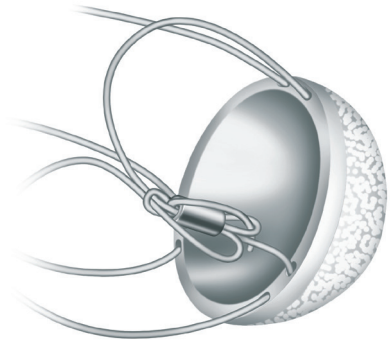

Figure 5

It is recommended to free the components from the host bone with curved rongeurs or appropriate method before proceeding.

If the acetabular cup is well fixed the plastic coated cable may break. If this occurs, remove the broken cable and replace it with the uncoated cable. To help thread the thicker uncoated cable, the ends should be shaped into a curve.

Further Information

For further information on the Acetabular Cup Extraction Kit, please contact Smith & Nephew Orthopaedics Ltd.

Catalog

BHR° Resurfacing Head

Cat. no.	Size
74123148	48mm
74121150	50mm
74123152	52mm
74121154	54mm
74123156	56mm
74121158	58mm

US Cat. no.	Size
7412314888	48mm
7412115088	50mm
7412315288	52mm
7412115488	54mm
7412315688	56mm
7412115888	58mm



BHR Acetabular Cup

Cat. no.	Size
74122154	54mm (48 head)
74122156	56mm (48 head)
74120156	56mm (50 head)
74120158	58mm (50 head)
74122158	58mm (52 head)
74122160	60mm (52 head)
74120160	60mm (54 head)
74120162	62mm (54 head)
74122162	62mm (56 head)
74122164	64mm (56 head)
74120164	64mm (58 head)
74120166	66mm (58 head)

US Cat. no.	Size
7412215488	54mm (48 head)
7412215688	56mm (48 head)
7412015688	56mm (50 head)
7412015888	58mm (50 head)
7412215888	58mm (52 head)
7412216088	60mm (52 head)
7412016088	60mm (54 head)
7412016288	62mm (54 head)
7412216288	62mm (56 head)
7412216488	64mm (56 head)
7412016488	64mm (58 head)
7412016688	66mm (58 head)



BHR° Dysplasia Cup

Cat. no.	Size
74122256	56mm
74120258	58mm
74122260	60mm
74120262	62mm
74122264	64mm
74120266	66mm



BHR Cup Screw

Cat. no.	Size
74500024	24mm
74500028	28mm
74500032	32mm
74500036	36mm
74500040	40mm
74500044	44mm
74500048	48mm
74500052	52mm
74500056	56mm
74500060	60mm
74500064	64mm
74500068	68mm
74500072	72mm
74500076	76mm
74500080	80mm
74500084	84mm
74500088	88mm



*For US Market Only

Products may not be available in all markets because product availability is subject to the regulatory and/or medical practices in individual markets. Please contact your Smith+Nephew representative or distributor if you have questions about the availability of Smith+Nephew products in your area. For detailed product information, including indications for use, contraindications, precautions and warnings, please consult the product's applicable Instructions for Use (IFU) prior to use.

Smith & Nephew Orthopaedics Ltd
Harrison Way
Leamington Spa
Warwickshire UK CV31 3HL

www.smith-nephew.com

Telephone: 1-901-396-2121
Information: 1-800-821-5700
Orders and Inquiries: 1-800-238-7538

° Trademark of Smith & Nephew.
All trademarks acknowledged

©2024 Smith & Nephew, Inc.
All rights reserved.
04727-us V4 45670103 REVE 05/24